

6800-E07

VISCO™



 **ATAGO**®
www.atago.net/

Quick Manual (using L Beaker as an example)

1. Setup (👉 p.9)

- ① Rotate the main unit's legs and position it upright.
- ② Place the main unit on the stand.

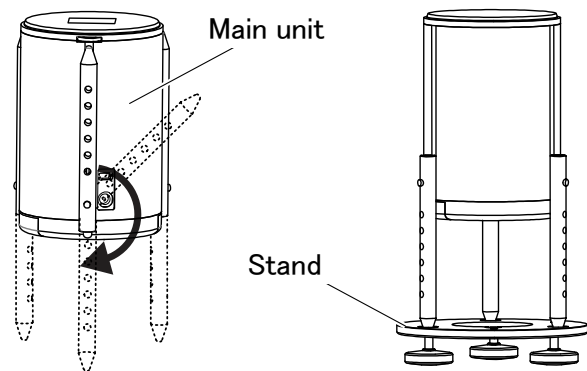

2. Power ON (👉 p.10)

- ① Push the dial button (for at least 0.5 seconds).
The main menu screen will be displayed.

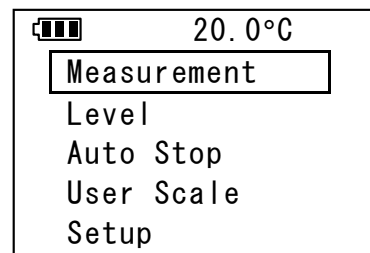
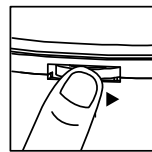

3. Level Check (👉 p.12)

- ① Use the screws at the base of the stand to adjust the level. Align the mark with the center of the screen.

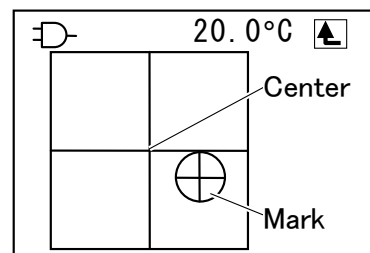
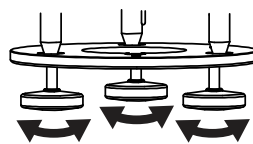

4. Spindle and Beaker Selection (👉 from p.42)

- ① Refer to the "Maximum Measurement Values Guideline Chart" and select the most suitable spindle and beaker for your application.

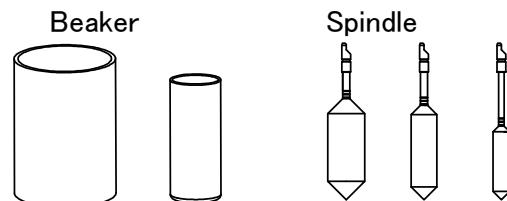

5. Spindle and Temperature Sensor Preparation (👉 from p.14)

- ① Attach the spindle and the temperature sensor to the main unit.

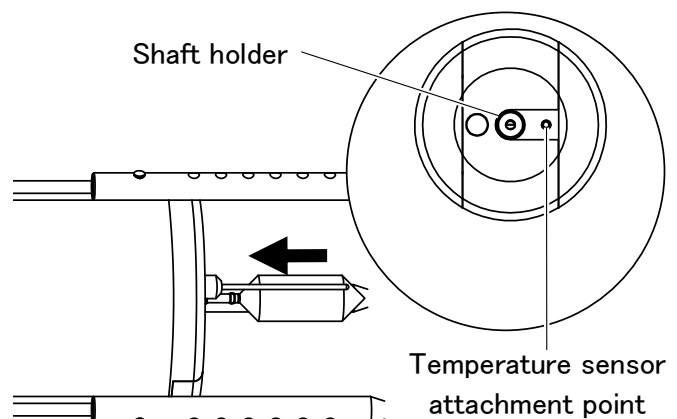

Quick Manual (using L Beaker as an example)

6. Sample Preparation (👉 p.15)

- ① Pour the sample in the beaker.

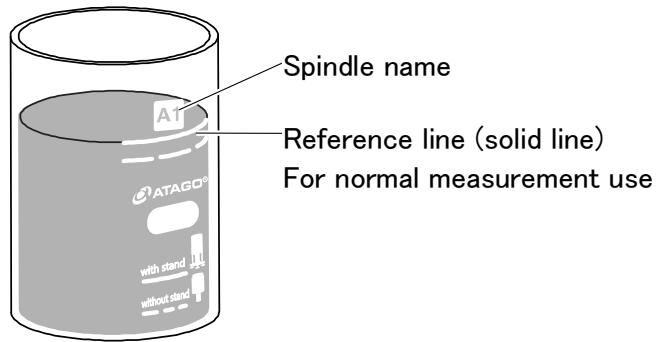

memo Reference lines may not be present on some beakers.

7. Beaker Setup (👉 p.16)

- ① Attach the beaker to the stand.
- ② Place the main unit on the stand.
- ③ Check that the surface of the sample is level with the spindle's reference line.

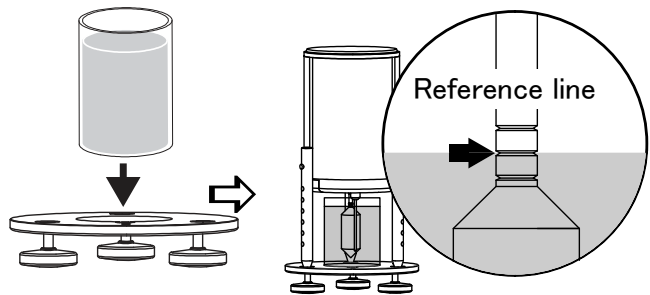

8. Settings (👉 p.17)

- ① Set the spindle/beaker type and speed.

memo For your convenience, "Auto Stop" (👉 p.25), "User Scale" (👉 p.27), and "Moving Average" (👉 p.33) functions are available.

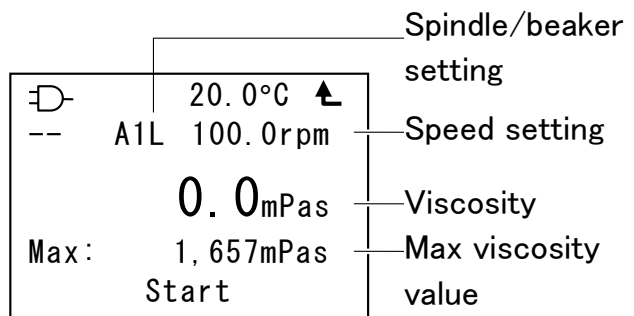

9. Measurement (👉 p.18)

- ① Select "Start" to begin measurement. Measurement values will be displayed.

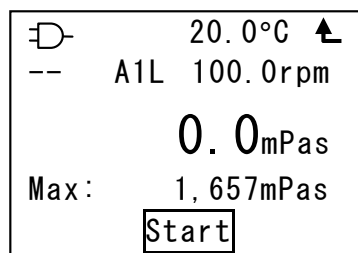

- ② Select "Quit" to terminate measurement.

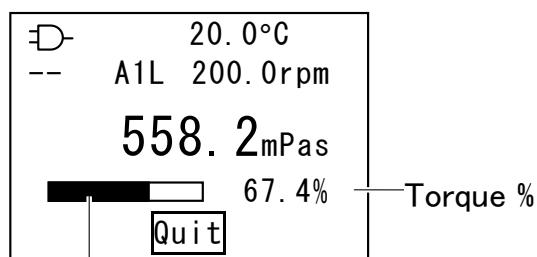

memo Cleaning (👉 p.24)

memo Basic Settings (👉 p.31)

Torque % bar

Measurement Tips

How can I obtain stable measurement values?



For stable measurement values, always perform measurements under the same conditions.

Changes in viscosity may occur due to varying conditions.

Sample Temperature

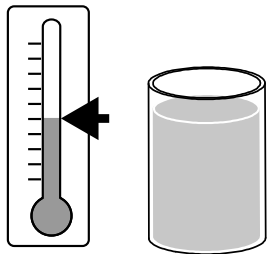

Spindle and Beaker Combination

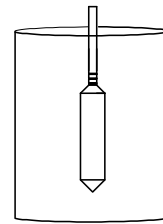

memo Measurement values may differ depending on the distance between the spindle and the beaker.

Measurement Time

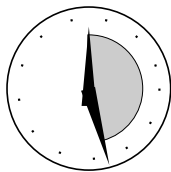

Speed

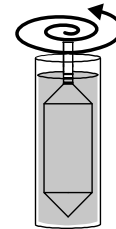

Sample Amount

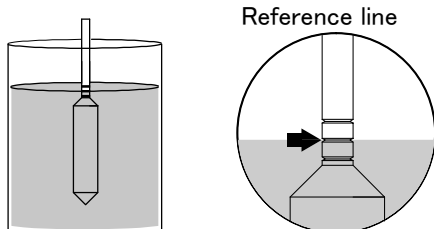

memo Check that the surface of the sample is level with the spindle's reference line.

Measurement Tips

**Which beaker and spindle should I choose?
Which speed setting should I select?**



Low

Sample Viscosity

High

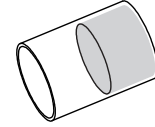

The sample does not readily dribble out even when turned upside-down.

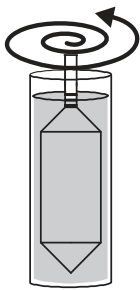

Higher.....Speed.....Lower

Wider.....Spindle.....Thinner

15mL.....Beaker.....100mL

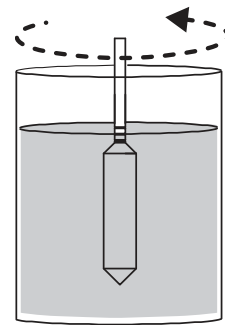

Dial Button Operation

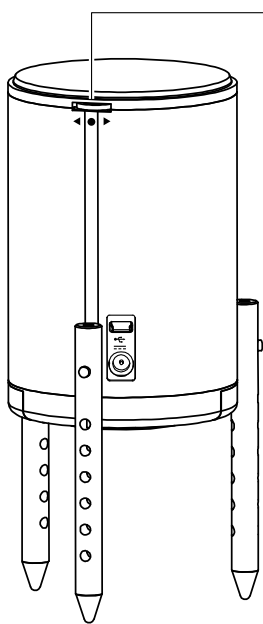

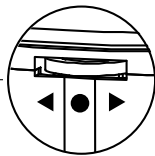

Posterior Illustration



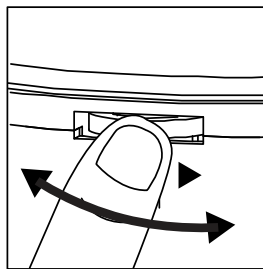

Dial button

Operation

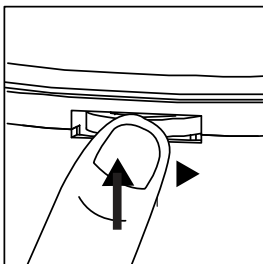

Slide (will be indicated by  throughout this manual)
Slide the dial button to change settings and item selections.



Push (will be indicated by  throughout this manual)
Push the dial button to power the instrument ON/OFF.
Use to confirm settings and item selections.

CONTENTS

1	Introduction.....	3
1-1	Important Information.....	3
1-2	Safety Information	3
1-3	Precautions.....	6
2	Instrument	7
2-1	Content.....	7
2-2	Names and Functions of Components	7
2-3	Inserting the Batteries (when using batteries as a power source).....	9
2-4	Setup	9
2-5	Power ON/OFF.....	10
2-6	Displays	11
2-7	Level Check.....	12
3	Measurement.....	13
3-1	Measurement Screen.....	13
3-2	Measurement Procedures	14
3-2-1	Spindle Preparation	14
3-2-2	Temperature Sensor Preparation.....	15
3-2-3	Sample Preparation	15
3-2-4	Beaker Setup	16
3-2-5	Spindle/Beaker Settings	17
3-2-6	Speed Settings	17
3-2-7	Measurement.....	18
3-3	Computer Output	19
3-3-1	Driver Installation	19
3-3-2	Computer – Data Setting.....	21
3-3-3	Data Output From Instrument to PC.....	22
3-3-4	Saving Data and Disconnecting.....	23
4	Cleaning	24
4-1	Main Unit.....	24
4-2	Spindles	24
5	Error Messages	24
6	Auto Stop.....	25
6-1	Screen Display.....	25
6-2	Auto Stop ON/OFF and Setting Value Input.....	26
7	User Scale	27
7-1	Preparation	27
7-2	Creating a User Scale	28
7-2-1	Screen Display.....	28
7-2-2	Viscosity Input.....	29
7-2-3	User Scale ON/OFF and Scale Number Settings.....	30
8	Basic Settings (setup).....	31
8-1	Setup Screen	31

8-1-1	Language	31
8-1-2	Unit Display.....	31
8-1-3	Date/Time	32
8-1-4	Brightness.....	32
9	Moving Average.....	33
9-1	Moving Average ON/OFF	33
10	User Calibration	34
10-1	Troubleshooting Tips	34
10-2	User Calibration.....	35
10-2-1	Display	35
10-2-2	Spindle/Beaker Settings.....	36
10-2-3	Standard Liquid Viscosity Settings.....	36
10-2-4	Performing User Calibration.....	37
10-3	Restore Default Calibration Settings.....	38
11	Abnormal Measurement Values	39
12	Optional Accessories and Replacement Parts	41
13	Supplementary Material.....	42
13-1	Maximum Measurement Values Guideline Chart	42
14	Warranty, Repair and Calibration.....	44
15	Specifications.....	45

1 Introduction

1-1 Important Information



Thank you for purchasing VISCO/VISCO-895. Before using the instrument, read this instruction manual carefully. Keep this manual on hand for future reference.

Pay particular attention to the "Safety Information" section, as understanding the contents is necessary for safe operations.



1-2 Safety Information

Please read and understand the following safety instructions to ensure safe use of the instrument. Failure to do so could result in injury and/or damage. The definitions of the icons and symbols can be found below.

Explanation of Icons

 WARNING	If this indication is neglected and the instrument is handled incorrectly, serious injury and death may result.
 CAUTION	If this indication is neglected and the instrument is handled incorrectly, injury and damage to one's property may result.

Explanation of Symbols

	This symbol denotes an item that you are warned or cautioned of (a warning item). The contents are described in detail in or near the Δ .
	This symbol denotes an action that must not be performed (a prohibited item). The contents are described in detail in or near the \bigcirc .
	This symbol denotes an action that must be performed (an action item). The contents are described in detail in or near the \bullet .

Instrument Handling and Maintenance

WARNING

- When measuring a substance harmful to the human body, be well aware of its properties and wear protective gloves, mask, etc.



- If the instrument begins to smell abnormally, overheat, or emit smoke, turn off the power switch and disconnect the power plug immediately. Continued use of the instrument may result in fire or malfunction. Contact your ATAGO distributor for an inspection.



- Do not attempt to repair, modify, or disassemble the instrument yourself. Improper servicing may result in fire, electrical shock, or burns.



- If the instrument is dropped or is subjected to a strong shock, contact ATAGO or an Authorized ATAGO Service Center nearby for an inspection. Continued use of the instrument may result in fire or malfunction.



CAUTION

- Do not apply water or sample over any part of the instrument. This may result in a malfunction.



- Always turn off the power switch after use.



- When transporting the instrument, place it in its original box. Always attach the protective cap to the shaft holder.



- Do not place excessive force or undue stress on the shaft holder. This may cause damage to the shaft holder.



- Carefully read this instruction manual and fully understand the function and operation of each part of the instrument before use.
- Check that each part of the instrument operates normally before use.
- Perform the necessary operation checks, such as calibration, according to the instruction manual.
- ATAGO shall not be held responsible for any or all damages as a result of use of the instrument for those other than its intended purposes (viscosity measurement of liquid samples).
- ATAGO shall not be held responsible for any or all undesired effects on the consumption or application of the measured materials that may occur as a result of use of the instrument.
- Only use the specified battery type. Observe proper polarities, properly aligning the anodes and cathodes.
- Remove the batteries and store them in the carrying case during air transport.

Plug Handling and Maintenance

WARNING

- | | |
|---|--|
| <ul style="list-style-type: none">• Be sure to use the AC adapter included with the instrument. If an AC adaptor other than the one included is used, the rated voltage and polarity of the power may be different and may cause smoke or fire. | <ul style="list-style-type: none">• Do not insert the plug of the AC adapter in an outlet other than AC100 to 240V. Inserting the plug in any other outlet may result in short circuiting the instrument, smoke or fire. |
|---|--|



- | | |
|--|--|
| <ul style="list-style-type: none">• Do not use the AC adapter if damaged or broken. Using a damaged AC adapter may result in fire, electrical shock, or burns. | |
|--|--|



CAUTION

- | | |
|--|--|
| <ul style="list-style-type: none">• Do not insert or disconnect the plug with wet hands. | <ul style="list-style-type: none">• Be sure to hold and gently pull the plug when disconnecting the cable from the outlet. Yanking or pulling the cable improperly may damage the plug and result in fire or electrical shock. |
|--|--|



1-3 Precautions

Ambient Conditions

- Use the instrument at an altitude below 2,000 m (above sea level).
- Use the instrument indoors.
- Use the instrument on a flat and level surface such as a desk or table.
- Use the instrument where the temperature is between 10 to 40°C.
- Do not leave the instrument in a location exposed to direct sunlight or near a heating unit where the temperature may rise.
- Do not expose the instrument to sudden temperature changes.
- Do not place the instrument in a place where it may be subject to strong vibrations.
- Do not use the instrument where there is much dust.
- Do not leave the instrument where the temperature is extremely low.
- Do not leave the instrument in a humid place.
- Do not place or drop heavy objects on the instrument.
- Use the instrument under temperature conditions where relative humidity is 80% at 31°C or lower, decreasing linearly to 50% at 40°C.
- Main power supply voltage fluctuation should not exceed $\pm 10\%$ of the nominal voltage.
- Transient voltage: IEC Installation Category (Overvoltage Category) II
- Pollution degree: 2 (IEC60664)

Handling

- Do not drop the instrument or subject it to any strong shock.
- Cables may be damaged if mishandled in any of the following manner:
 - Bending the cable.
 - Pulling the cable.
 - Placing the cable under heavy objects.
 - Placing the cable between heavy objects.

Daily Maintenance

- Thoroughly clean the spindles, beakers and temperature sensor, then dry them well.
- If the instrument becomes dirty, wipe with a soft cloth.
- Do not use benzine, paint thinner, etc. to clean the instrument.

2 Instrument

2-1 Content

Main unit.....1	S Beaker (15mL).....1	Instruction manual (this book) ... 1
Stand.....1	L Beaker (100mL).....1	Inspection certificate 1
Spindles (A1, A2 and A3).....one each	AC adapter.....1	Spindle stand 1
Temperature sensor.....1	USB Mini-B cable (1m).....1	Protective cap.....1
Small volume beaker attachment.....1	1.5V AA alkaline batteries.....4	Carrying case.....1

2-2 Names and Functions of Components

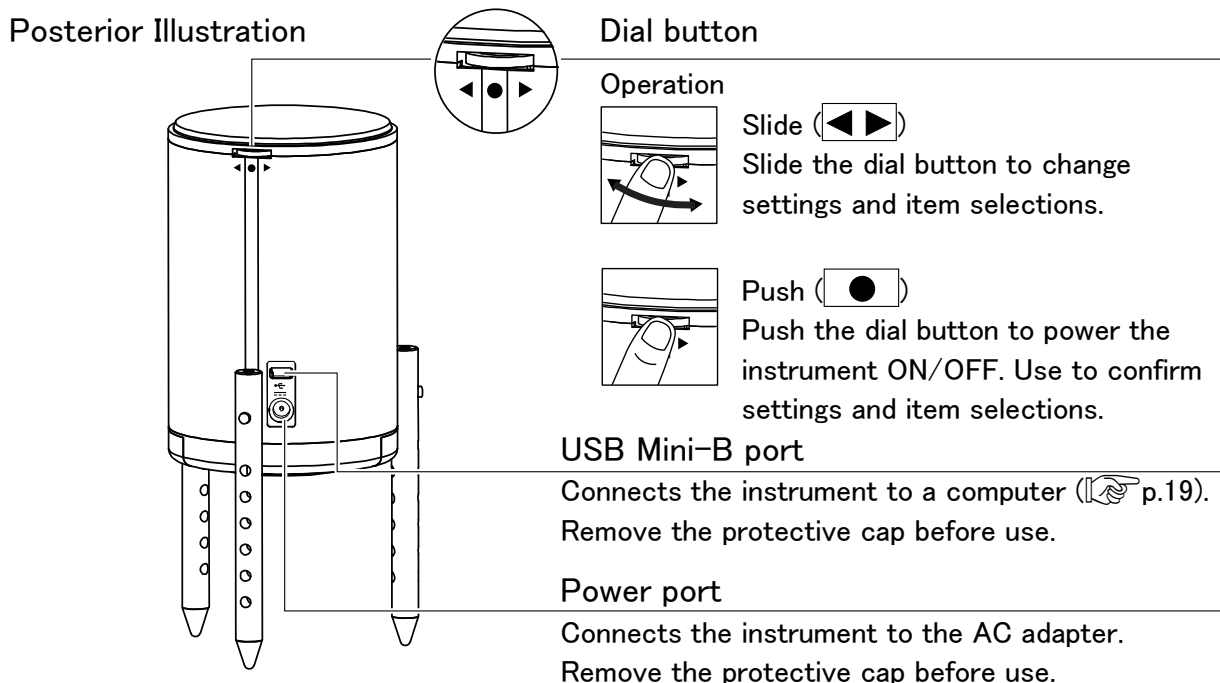
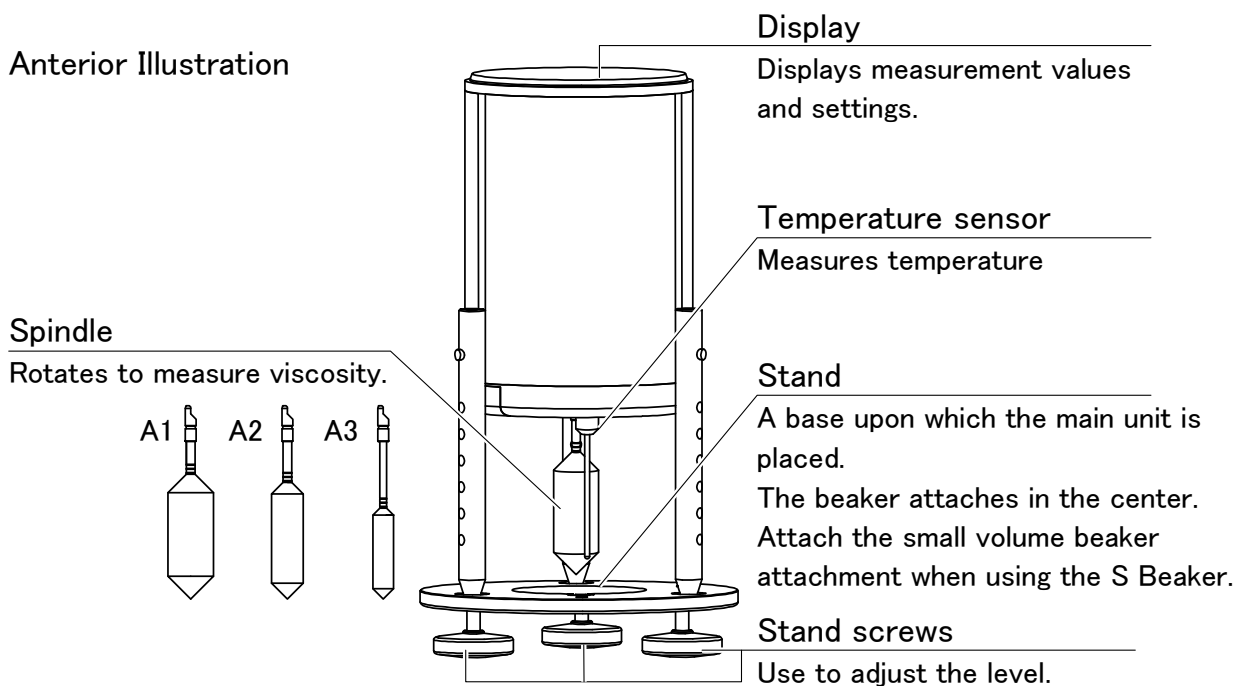

Underside Illustration (main unit)

Battery compartment screw

Turn to remove the battery compartment cover.

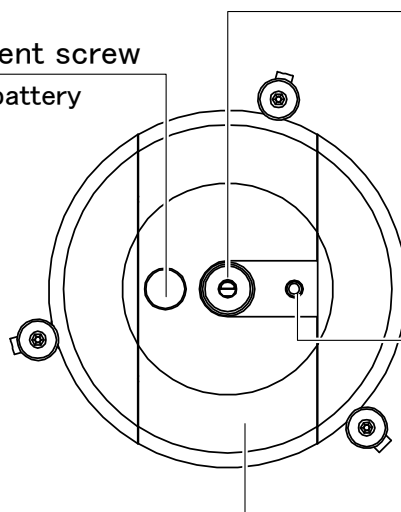

Shaft holder

The spindle attaches here.

Remove the protective cap before use.

Note Do not place excessive force or undue stress on the shaft holder. This may cause damage to the shaft holder.

Temperature sensor attachment point

The temperature sensor attaches here.

Battery compartment

Remove the cover to insert and replace batteries.



S Beaker (15mL)

Place sample in this container.

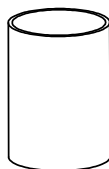

L Beaker (100mL)

Place sample in this container.



Small volume beaker attachment

Attach the small volume beaker attachment to the stand when using the S Beaker.

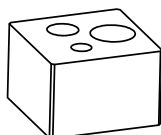

Spindle stand

Insert the spindle and store upright.



Protective cap

Always attach the protective cap to the shaft holder when storing the instrument in the carrying case.

memo Remove the battery compartment cover to attach/detach the protective cap.

2-3 Inserting the Batteries (when using batteries as a power source)

Note

- When  is indicated, replace all batteries with brand new AA alkaline batteries (x 4).
- Check the expiration dates on batteries before purchase. Always use only brand new batteries.
- Do not place the display-side of the instrument facedown. This may result in damage to the display.

1. Turn the battery compartment screw in the direction of the arrow (counterclockwise). Remove the battery compartment cover.

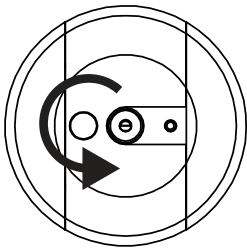

2. Gently pull out the battery case and insert the batteries.

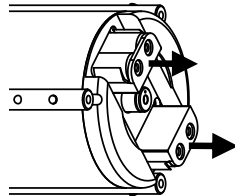

Note

Insert the batteries, observing the correct polarities.

3. Insert the battery case.

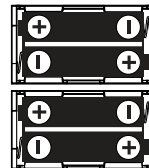
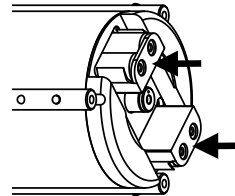

4. Affix the battery compartment cover and push it in, while turning the battery compartment screw in the direction of the arrow (clockwise).

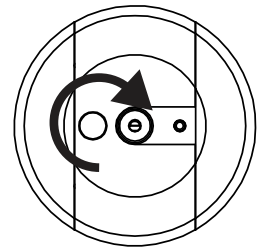

2-4 Setup

1. Rotate the main unit's legs and position it upright.

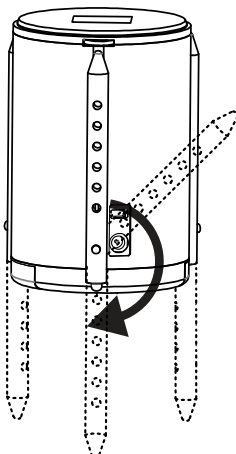

2. Place the main unit on the stand.

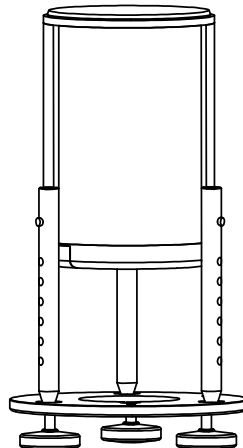

Note

Insert the legs into the grooves on the stand.

Note

Subjecting the shaft holder to sudden shock or excessive force may result in damage and malfunction. Always rotate the instrument's legs and keep the instrument in an upright position, except when storing it in its protective case.

2-5 Power ON/OFF

Power ON

When using an external power source, connect the AC adapter to an indoor AC100 to 240V (50Hz/60Hz) power outlet.

 Push for 0.5 seconds.

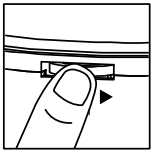

Beep



[Startup Screen]
(The soft ver. is for example.)

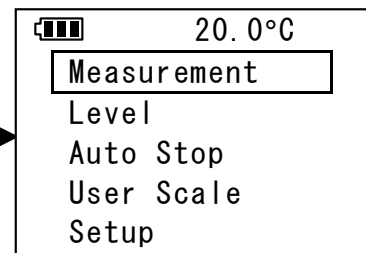

[Main Menu Screen]

Power OFF

 Push for at least 3 seconds.

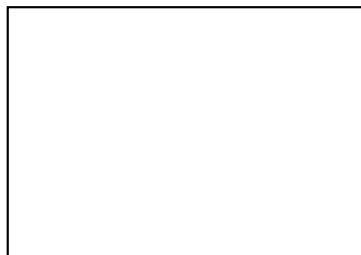
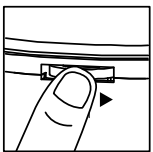

The display will turn off.

memo When using batteries as a power source, the instrument will automatically power OFF after 5 minutes of inactivity.

2-6 Displays

After the startup screen appears, the main menu screen will be displayed.

[Main Menu Screen]

From the main menu screen, you can switch the display between measurement, level check and setup.

Remaining battery charge/External power supply indicator

Battery power source: remaining battery charge indicator  will be displayed.

External power source:  will be displayed.

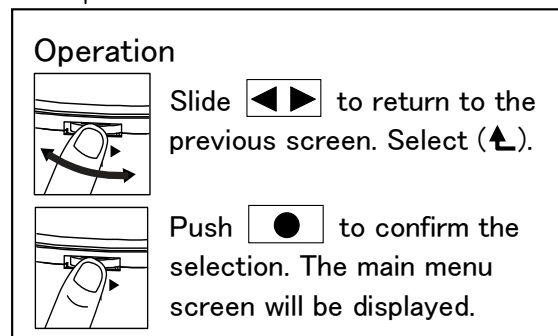
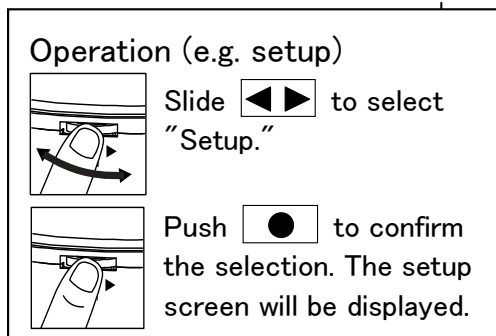
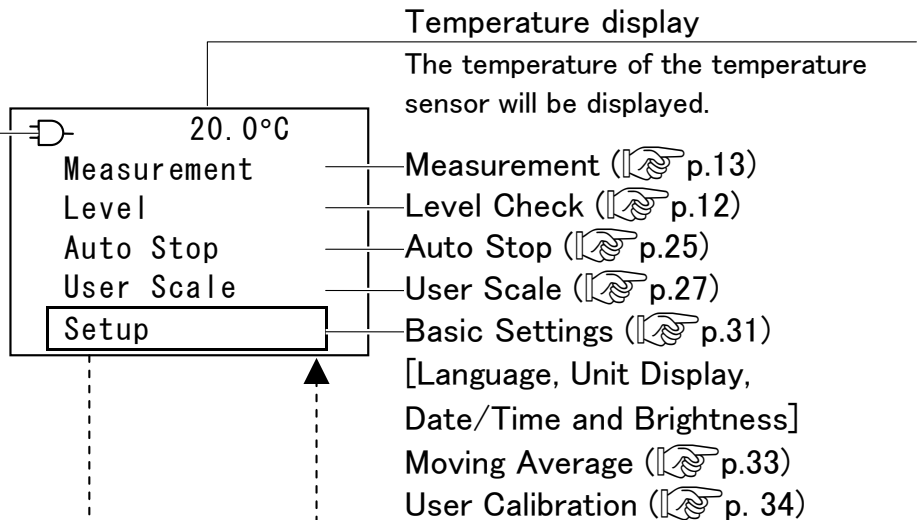

[Setup Screen]

From the setup screen, you can switch the display between basic settings, moving average and user calibration.

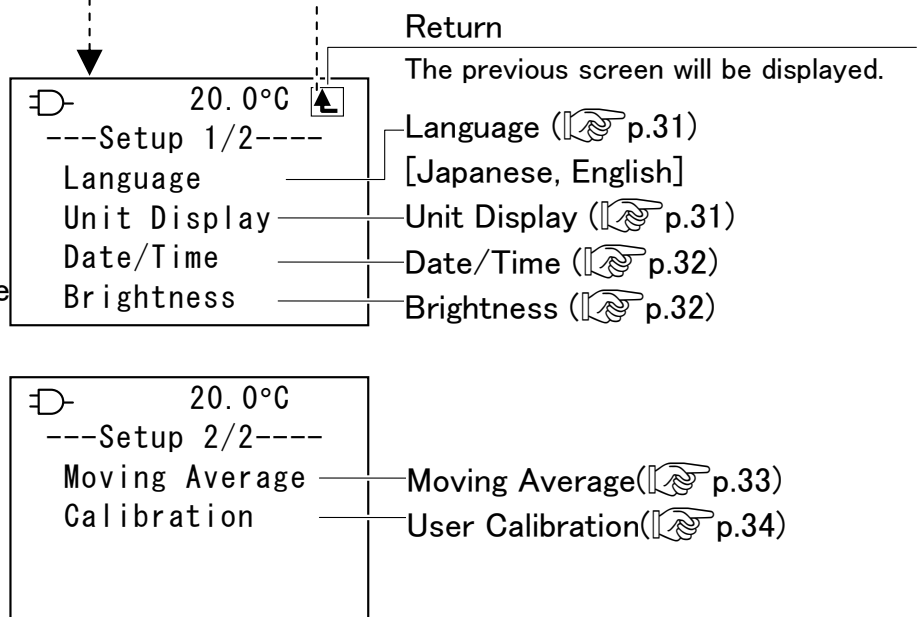

memo After 30 seconds of inactivity, the brightness level will auto-adjust to "1."

2-7 Level Check

Use the stand screws to adjust the level of the main unit.

Setup (👉 p.9)

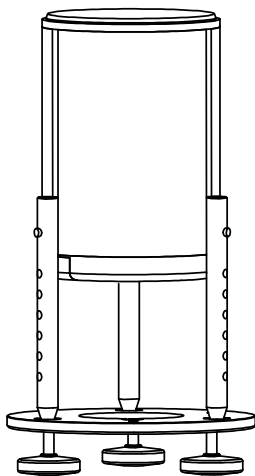

[Main Menu Screen]

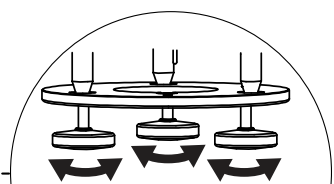
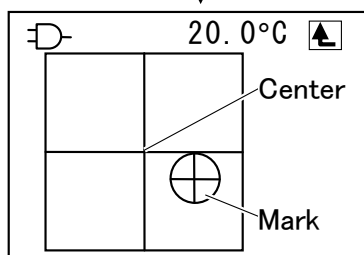
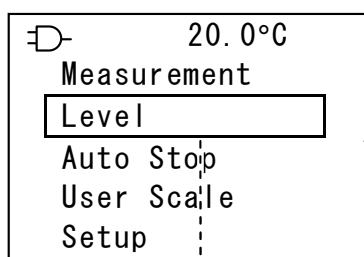

Use the stand screws to adjust the level. Align the mark with the center of the screen.

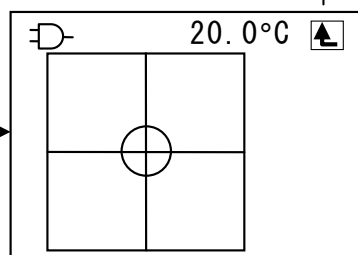

Confirm

3 Measurement

Note

- Ensure that the main unit, spindle, temperature sensor, beaker and sample are fully acclimated to the ambient temperature before taking measurements.

3-1 Measurement Screen

[Main Menu Screen]

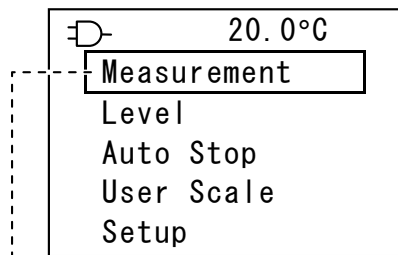

[Measurement Screen]

Moving Average (👉 p.33)

An icon will be displayed when this function is on.

ON:

OFF: Not displayed.

Auto Stop (👉 p.25)

An icon will be displayed when this function is on.

ON: (Viscosity), (Torque), (Time)

OFF: Not displayed.

Remaining battery charge/External power supply indicator

Battery power source: remaining battery charge indicator

will be displayed.

External power source:

will be displayed.

User Scale (👉 p.27)

ON/OFF is displayed.

Set ON/OFF.

ON: 01 to 10 (Scale Number)

OFF: --

Max viscosity value

The max viscosity value is displayed.

memo This indicates the max viscosity value that can be measured with the selected spindle/beaker and speed combination.

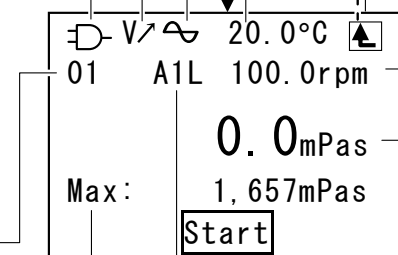

Temperature

The temperature of the temperature sensor is displayed.

Return

The main menu screen will be displayed.

Speed

The speed is displayed.
The speed can be set.

Viscosity

The viscosity is displayed.

Start

Select "Start" to begin measurement.

Spindle/Beaker

The spindle and beaker combination is displayed.

3-2 Measurement Procedures

Before taking measurements, refer to the "Maximum Measurement Values Guideline Chart" and select the most suitable spindle and beaker for your application.

(☞ from p.42)

3-2-1 Spindle Preparation

Attach the spindle to the main unit.

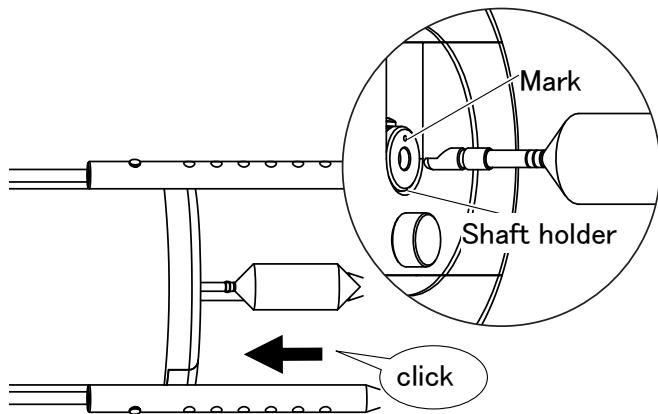

Note Insert the spindle all the way until you hear a faint "click."



Note Do not forcefully insert the spindle. Do not insert the spindle at an angle. Subjecting the shaft holder to excessive force may cause damage.

Note Do not grab or hold the spindle by the tip with bare hands. Grasp the shaft to insert the spindle. Wrap the spindle in tissue paper if grabbing or holding by the tip.

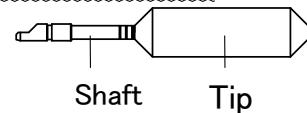

memo Remove the protective cap.

Spindle Types

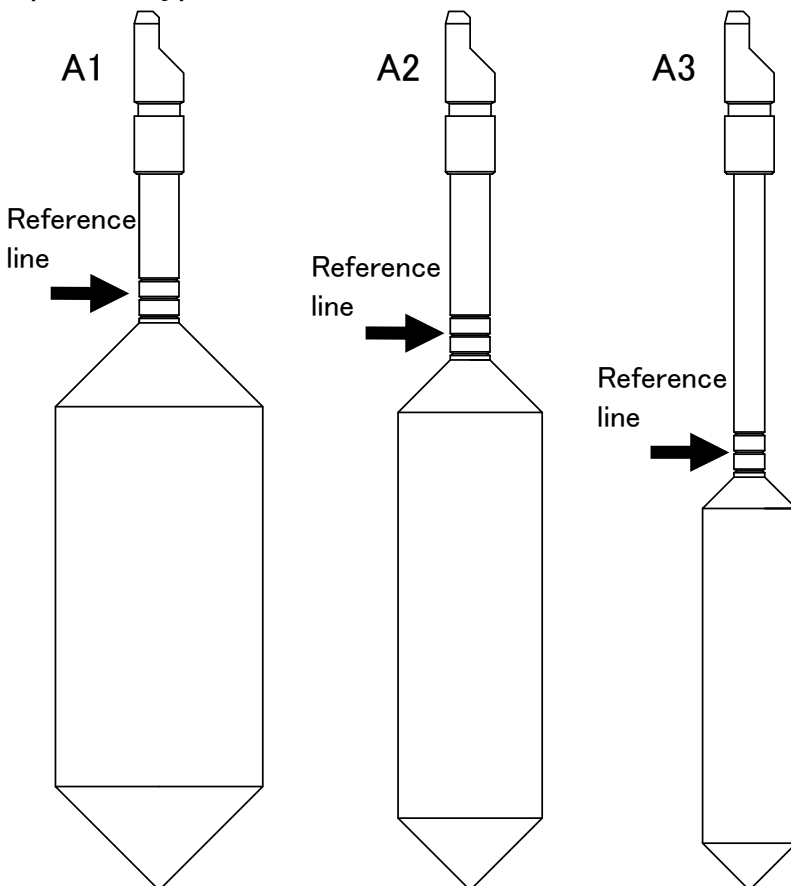

Note The reference line is between the fill lines.

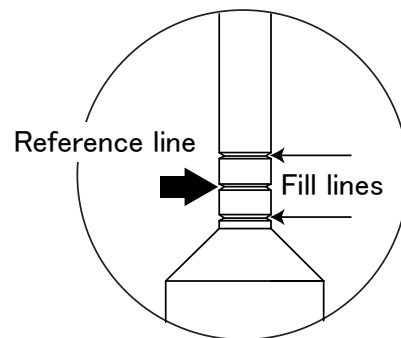

3-2-2 Temperature Sensor Preparation

Attach the temperature sensor to the main unit (Cannot be used with S beaker).

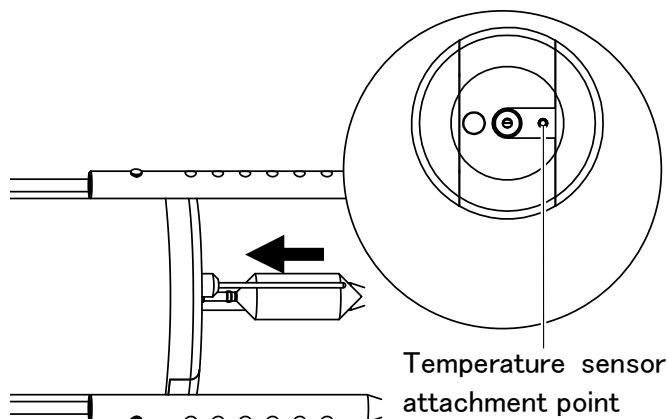

Note Insert the temperature sensor all the way until you hear a faint "click."

3-2-3 Sample Preparation

1. Pour some sample in the beaker up to the reference line.*

L Beaker (100mL)

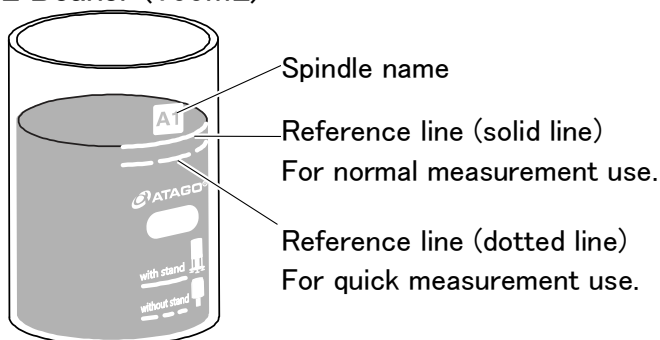

Note The reference line most suited to your application depends on the type of spindle that is used.

Note A reference line for normal measurements and a reference line for quick measurements are present only on the L Beaker.

Note Make sure that no air bubbles are trapped in the sample.

S Beaker (15mL)

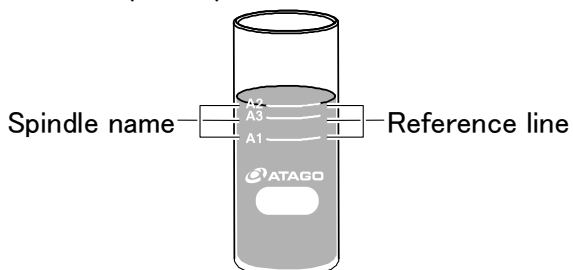

memo The illustration is for reference only and may differ from the actual product.

*If reference lines are not present on the beaker:

Align the surface of the sample with the spindle's reference line.

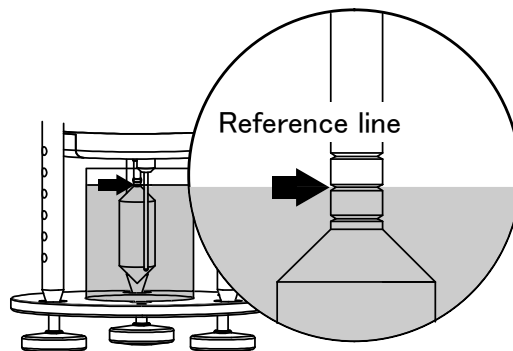

3-2-4 Beaker Setup

1. Attach the beaker to the stand.

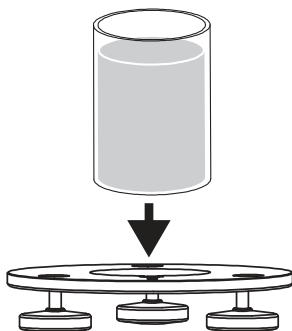

Note Firmly attach the beaker, ensuring there are no spaces or gaps between the beaker and the stand.

2. Place the main unit on the stand. Check that the surface of the sample is level with the spindle's reference line.

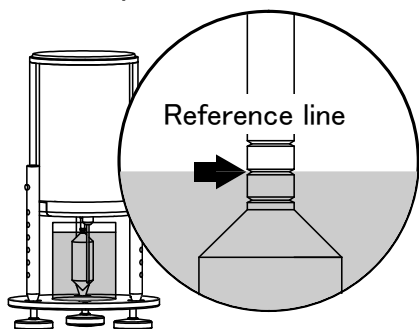

If using the S Beaker:

Attach the small volume beaker adapter to the stand. Then, attach the beaker.

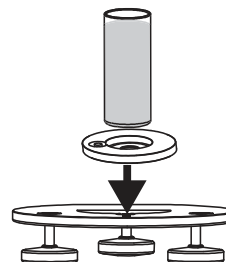

Note Firmly attach the small volume beaker adapter and beaker, ensuring there are no spaces or gaps between them and the stand.

Note Be sure that the spindle and temperature sensor do not come in contact with the beaker.

Note Make sure that no air bubbles are trapped in the sample. If air bubbles are present, let the sample sit and settle in order to remove the air bubbles.

Quick Measurements (accuracy not guaranteed)

Quick and easy measurements can be taken by placing the main unit directly on the L Beaker.

Note Quick measurements can only be taken with the L Beaker.

Note Pour some sample in the beaker up to the quick measurement reference line.

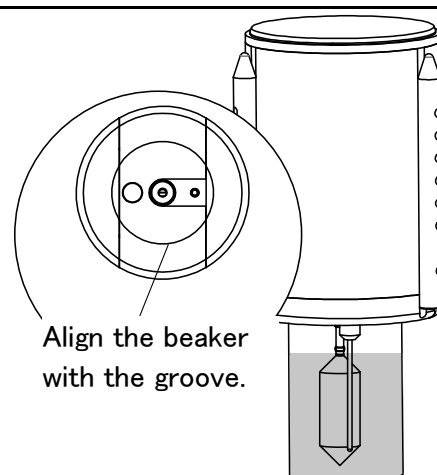
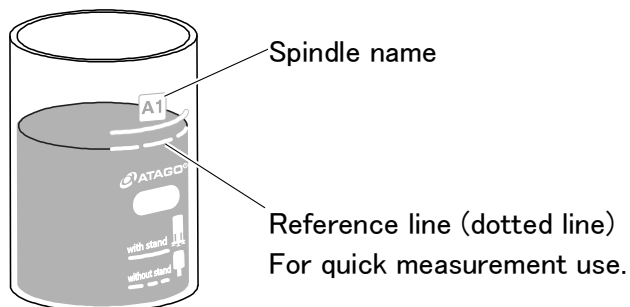

3-2-5 Spindle/Beaker Settings

This section explains how to set the spindle/beaker combination.

[Measurement Screen]

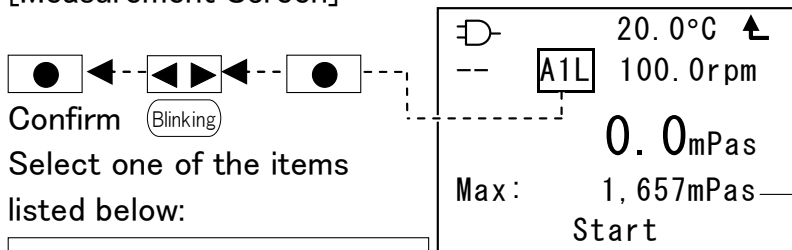

Select one of the items listed below:

Item	Spindle	Beaker
A1S	A1	S:15mL
A1L	A1	L:100mL
A2S	A2	S:15mL
A2L	A2	L:100mL
A3S	A3	S:15mL
A3L	A3	L:100mL
UL	-	-

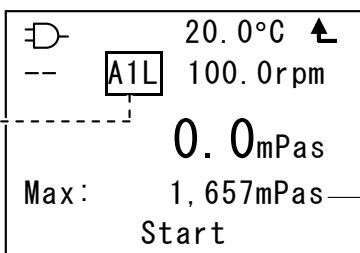

Max viscosity value

The max viscosity value will change every time the combination is switched.

memo Select UL when using Ultra Low Adapter (ULA)-Sample Adapter for Low Viscosity Sample (sold separately).

3-2-6 Speed Settings

memo Settings can be changed even during measurement.

[Measurement Screen]

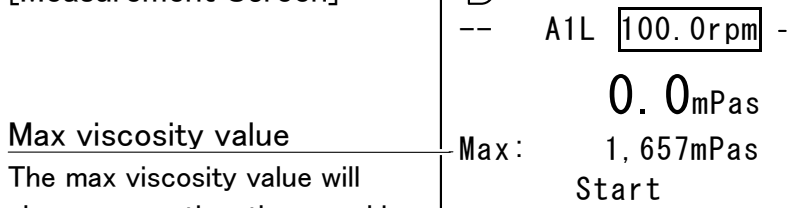

Max viscosity value

The max viscosity value will change every time the speed is switched.

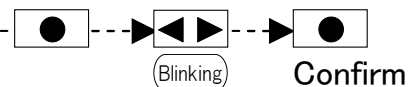
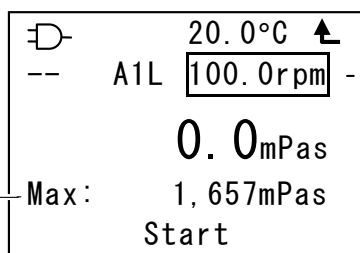



Select one of the speeds listed below:

- 0.5、0.6、1.0、1.5、2.0、2.5、
- 3.0、4.0、5.0、6.0、10、12、
- 20、30、50、60、100、150、
- 200、250 rpm



memo Select 2.5rpm or more when using Ultra Low Adapter (ULA)-Sample Adapter for Low Viscosity Sample (sold separately).

3-2-7 Measurement

[Measurement Screen]

Slide  to select "Start," then push  to confirm the selection and begin measurement.

[Screen During Measurement]

Slide  to select "Quit," then push  to confirm the selection and terminate measurement.

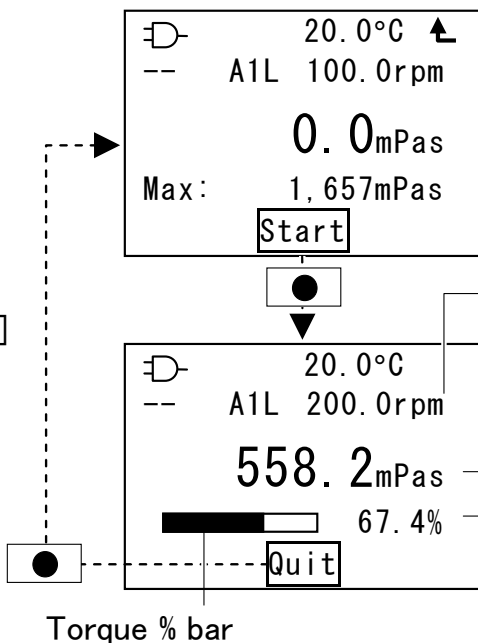



Speed

 Settings can be changed even during measurement.

Viscosity

Torque %

 The recommended range is 10.0 to 100.0% (and 5.0 to 100.0% when using Ultra Low Adapter (ULA)-Sample Adapter for Low Viscosity Sample (sold separately)). If the value falls outside of the above range, a "beep" will be emitted. ( p.39)

Removing the spindle:

While pressing on the shaft holder, pull the spindle straight out.

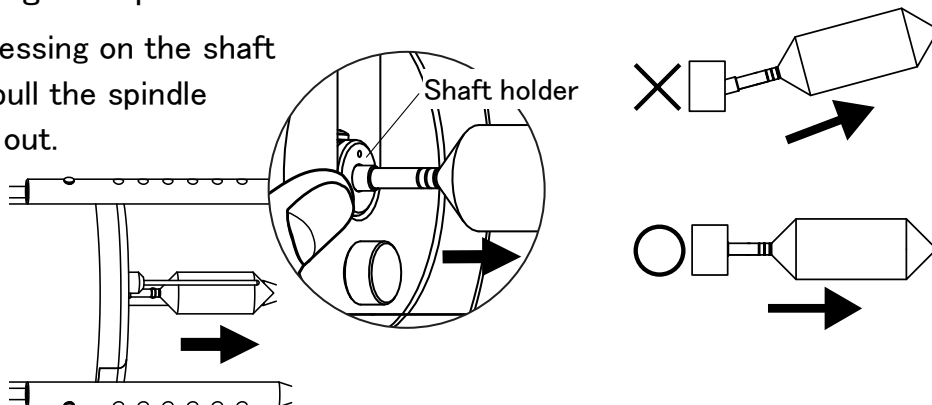

If changing the spindle:

1. Remove the spindle and temperature sensor.
2. Attach the spindle you wish to use and the temperature sensor. Be sure to wash the temperature sensor before re-attaching ( p.14).

Note Make sure no sample residue is left on the shaft holder or temperature sensor attachment point.

Note If sample residue is present on the spindle and temperature sensor, wash them thoroughly.

Note After changing the spindle, check that the surface of the sample is level with the spindle's reference line.

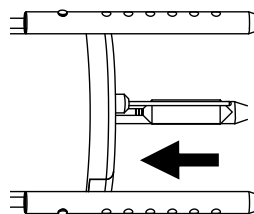

3-3 Computer Output

The instrument outputs measurement results in real-time via USB Mini-B.

3-3-1 Driver Installation

To have the instrument recognized by the PC, download a FTDI driver on the PC from the link below:

※ Install the virtual COM port (VCP) driver.

<http://www.ftdichip.com/FTDrivers.htm>

1. Ensure that the PC has started up completely.
2. Connect the cable to the instrument (see the posterior illustration on page 7, "Names and Functions of Components") and the PC.



USB type A (left) and USB type Mini-B (right)

3. Turn the instrument on.

Installation instructions are as follows (Windows 7 is used as an example):

4. "Device Driver Installation Wizard" will pop up.
5. Once the driver installation is complete, the instrument is recognized by the PC.

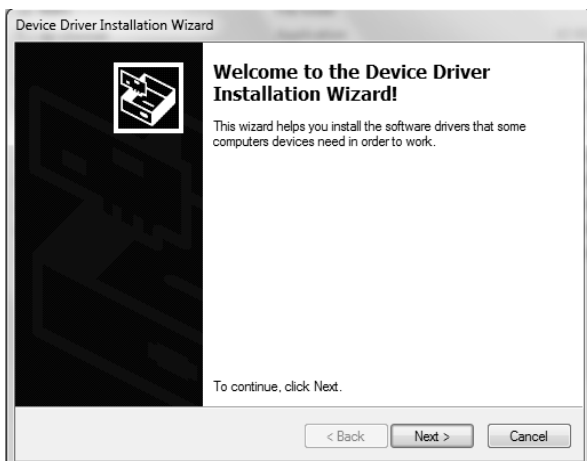

6. From "Control Panel," open "System and Security."
Click on "Device Manager," under "System."

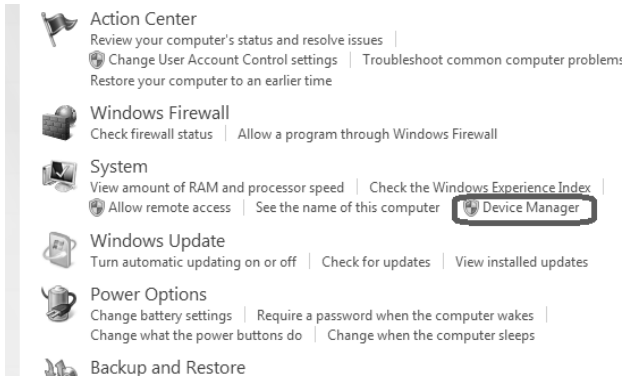

7. From the "Device Manager" options, click "Ports." Ensure that USB Serial Port (COM#) appears. Check the port number. In the example shown below, the port is COM3.

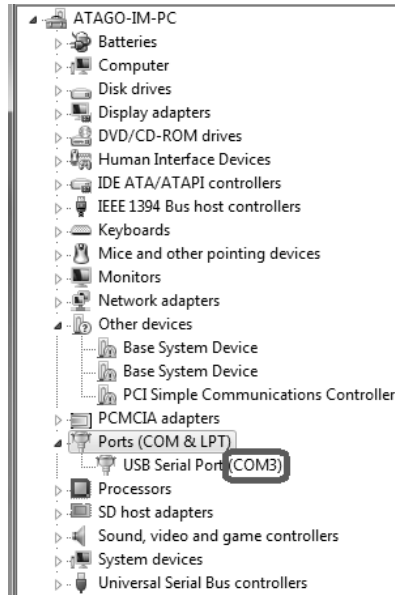

8. Click "USB Serial Port(COM"*)". From the "USB Serial Port(COM"*) Properties" window, configure the computer's COM port settings as shown below.

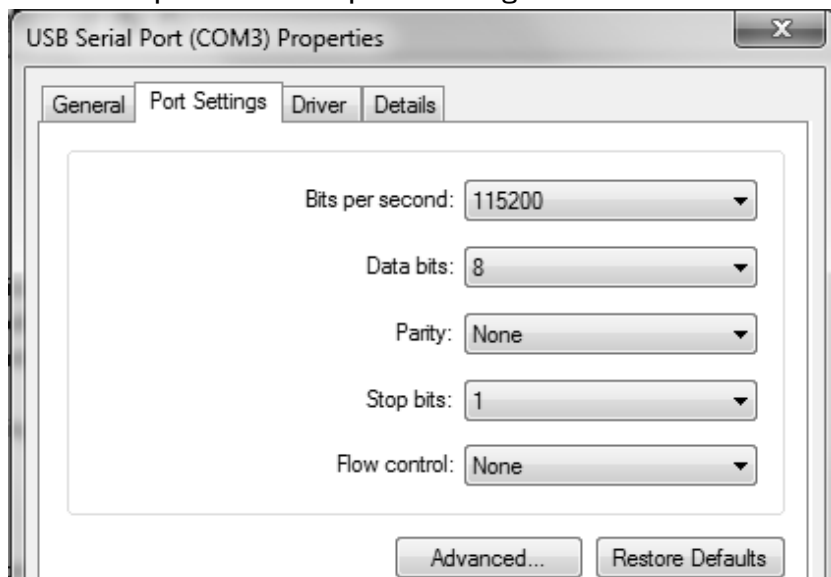

Note The port number may vary, depending on the PC and other connecting devices.

✘ Windows 98, Windows 2000, Windows Me, Windows XP, Windows Vista, and Windows 7, Windows 8 and Windows 10 are registered trade marks of Microsoft Corporation in the United States and other countries.

3-3-2 Computer – Data Setting

Download Tera Term from a website, such as the one below:

<http://ttssh2.sourceforge.jp/index.html.en>

1. Start Tera Term.

Select "Serial," and select the port number, which was confirmed in step 7 of "Driver Installation," on page 20, from the "Port:" drop-down menu.

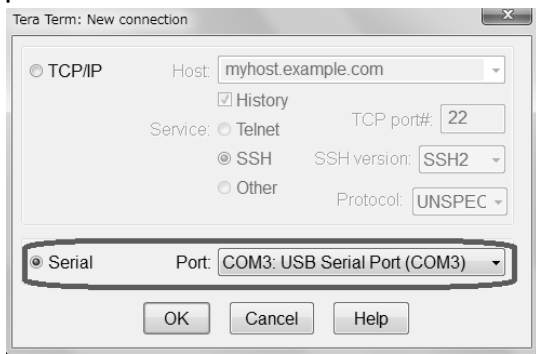

2. Click "Setup," and then "Serial port."

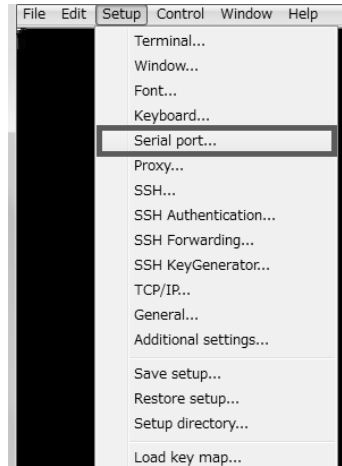

3. In the "Serial port setup" dialog box, enter the settings as shown below for the port number selected in step 7 of "Driver Installation," on page 20.

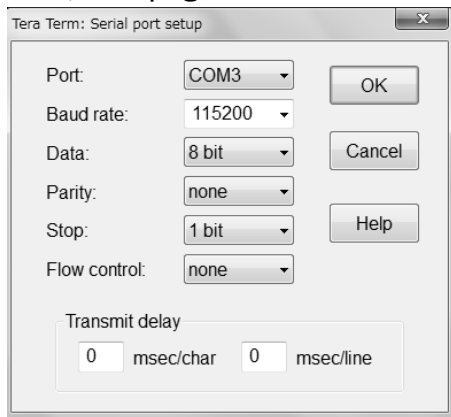

4. Click "Setup," and then "Terminal."

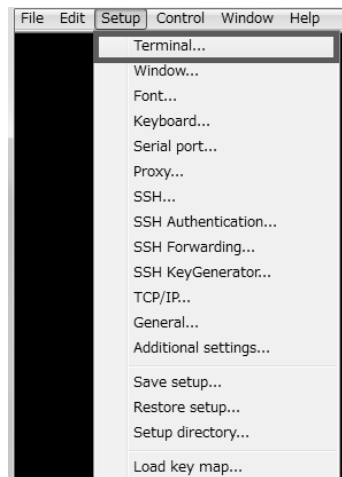

5. Enter the settings as shown below .

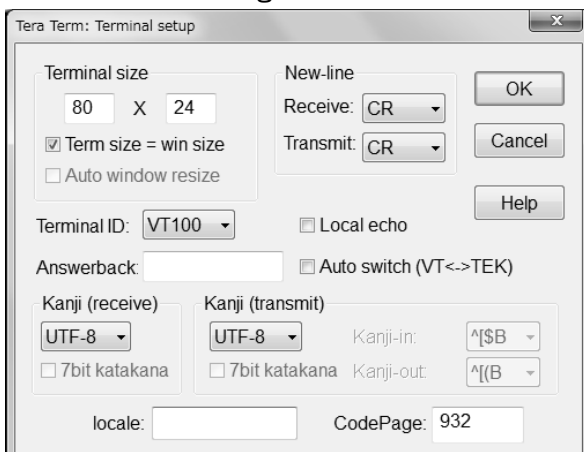

3-3-3 Data Output From Instrument to PC

Begin measurement.

Every time a measurement is taken (every time the spindle rotates), a new row of data appears in the Tera Term window.

- Data is output in ASCII code.
- Each item is separated by a comma.

[Data Display]

04/13/16,15:41:24,251.8,251.8,341.8,341.8,2037,mPas,12.4,12.4,27.9,degC,A2S,60.0,
Constant,1,01,10.0,20.0,30.0,100.0,110.0,120.0,-1.276756e-15,1.000000e+00,9.000000e+01

Data Display	Item	Item Detail
04/13/16	Date	MM/DD/YY (Under Japanese language settings, the date will be displayed in the format "YY/MM/DD")
15:41:24	Time	HH:MM:SS
251.8	Viscosity	
251.8	Moving Average Viscosity	
341.8	User Scale Viscosity	
341.8	User Scale Average Viscosity	
2037	Max Viscosity	
mPas	Unit readout (viscosity)	mPa·s / cP
12.4	Torque %	
12.4	Moving Average Torque %	
27.9	Temperature	
deg C	Unit readout (temperature)	deg C / deg F (Under Japanese language settings, the temperature unit readout can be displayed in either "°C" or "°F")
A2S	Spindle/beaker combination	
60.0	Speed	rpm

Data Display	Item	Item Detail
Constant	Motor status	Constant, Acceleration or Deceleration
1	Moving Average Function ON/OFF	0 : Moving average function is off. 1: Moving average function is on.
01	User Scale Function ON/OFF and Scale Number	-- : User scale function OFF 01 to10: Scale Number (User scale function ON)
10.0	X1	User Scale Input Value (Measurement Value 1 on this device)
20.0	X2	User Scale Input Value (Measurement Value 2 on this device)
30.0	X3	User Scale Input Value (Measurement Value 3 on this device)
100.0	Y1	User Scale Input Value (Measurement Value 1 on another viscometer)
110.0	Y2	User Scale Input Value (Measurement Value 2 on another viscometer)
120.0	Y3	User Scale Input Value (Measurement Value 3 on another viscometer)
-1.276756e-15	a	"a" in user scale conversion equation $v=ax^2+bx+c$
1.000000e+00	b	"b" in user scale conversion equation $v=ax^2+bx+c$
9.000000e+01	c	"c" in user scale conversion equation $v=ax^2+bx+c$
	Line terminator	CR LF

3-3-4 Saving Data and Disconnecting

Follow the instructions on saving files in Windows and Tera Term to save data.
Close Tera Term to end communication.

4 Cleaning

4-1 Main Unit

Note

- Disconnect all the cables and power OFF the instrument.
- Place the protective cap on the shaft holder after use.
- Subjecting the shaft holder to sudden shock or excessive force may result in damage and malfunction. Always rotate the instrument's legs and keep the instrument in an upright position, except when storing it in its protective case.

Gently wipe off the instrument using the cleaning methods outlined below:

- A soft, dry cloth, such as a lens or microfiber cloth.
- A cloth moistened with mild soap or ethyl alcohol.

4-2 Spindles

Note

- Wash the spindles after every use.
- When using highly volatile or flammable solvents, be sure to wear appropriate protective clothing, such as gloves, masks, etc.

- Wash the instrument with lukewarm water.
- Use mild soap, ethyl alcohol, or acetone when necessary.

5 Error Messages



- HHH : [Viscosity] This error message will appear If the torque value exceeds 100%.
(Refer to the "Abnormal Measurement Values"  p.39)
- [Temperature] This error message will appear if the temperature exceeds 105.0°C (221.0°F).
- LLL : [Temperature] This error message will appear if the temperature is below -5.0°C (27.0°F).
It will also appear if the temperature sensor is not attached.

6 Auto Stop

This function will automatically stop taking measurements when a set value is reached. This effectively measures the viscosity and torque % of a sample that changes over time by displaying a measurement value once it has stabilized. The set value can be selected from viscosity, torque, or time.

6-1 Screen Display

[Main Menu Screen]

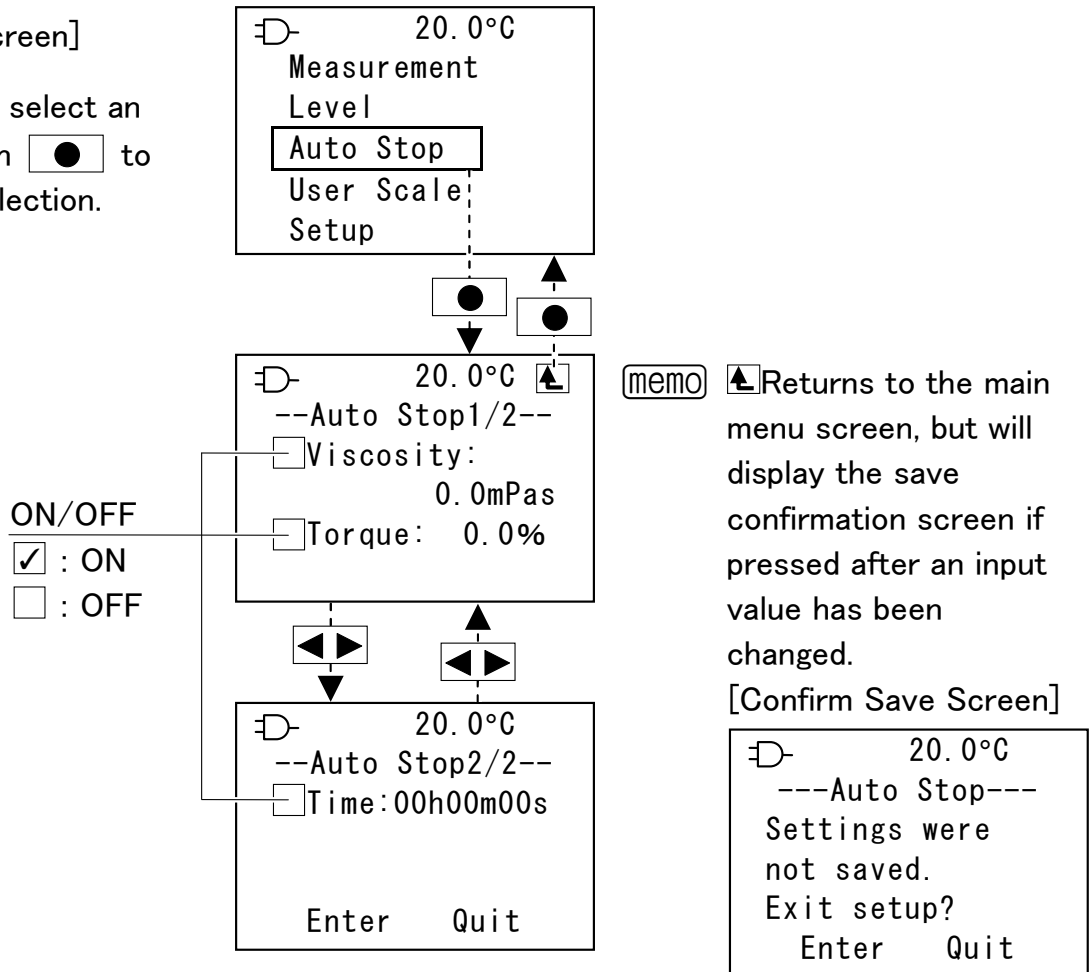

Slide  to select an item, then push  to confirm the selection.





6-2 Auto Stop ON/OFF and Setting Value Input

This section explains the auto stop function using viscosity as an example.

[Auto Stop Screen]

Slide  to select Visc, then push  to check the box.

Slide  to select viscosity value, then push  to continue to the input screen.

: use the arrows to move the cursor.

Back: select "Back" to delete the value to the left of the cursor.

 To turn off the auto stop function, uncheck the selection item boxes.

 Select "Quit" to discard settings and return to the auto stop screen.

 Values up to 1 decimal place can be input.

Save 

Exit without saving 

[Main Menu Screen]

[Main Menu Screen]

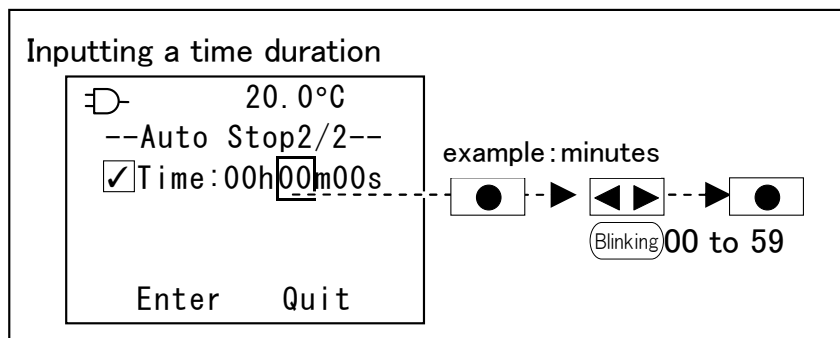

7 User Scale

This function allows the VISCO to display the same measurement values as a B-Type viscometer or other viscometer type.

A user scale is created for each sample.

The relationship between the measurement value from other viscometers (y) and the VISCO (x) is $y = ax^2+bx+c$

By inputting the viscosity measured by this device and another viscometer at three different speeds, the VISCO will automatically calculate the conversion factors a, b, and c.

- A maximum of 10 user scales can be saved.
- Turning the User Scale Function ON/OFF or selecting a Scale Number can be done from the measurement screen.

7-1 Preparation

Choose three speeds that will each be used by the VISCO and the other viscometer.

Prepare the measurement sample.

Measure the sample at all three speeds with the VISCO and the other viscometer.

The measurement value to enter into the VISCO is the value at which it stabilizes.

Note Ensure that the sample temperatures are the same.

[Example]

Scale Number:01			
Sample:A			
Speed Number	Speed [rpm]	Viscosity[mPa·s]	
		The VISCO's Measurement Value (X)	Other Viscometer's Measurement Value (Y)
1	30	5449	5810
2	50	4451	4763
3	60	4157	4400

7-2 Creating a User Scale

This section will explain how to create an example Scale Number 01.

7-2-1 Screen Display

[Main Menu Screen]

Slide ◀▶ to select an item, then push ● to confirm the selection.

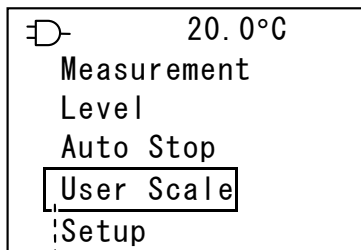

[Scale Setting Screen]

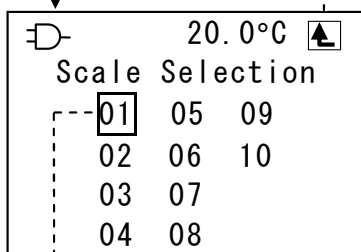

[Scale Setting (X) Screen]

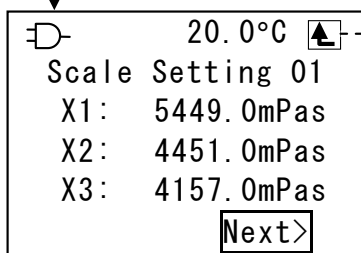

[Scale Setting (Y) Screen]

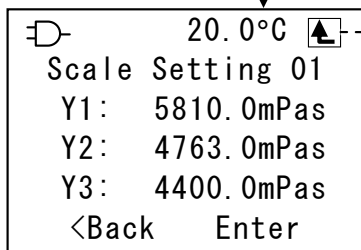

memo ▲ returns to the main menu screen, but will display the save confirmation screen if pressed after an input value has been changed.

[Save Confirmation Screen]

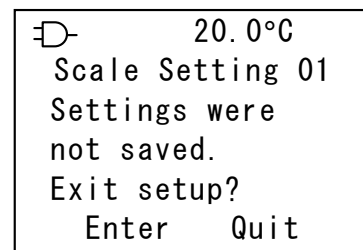

7-2-2 Viscosity Input

[Scale Selection Screen]

Slide to select a scale number, then push to confirm the selection.

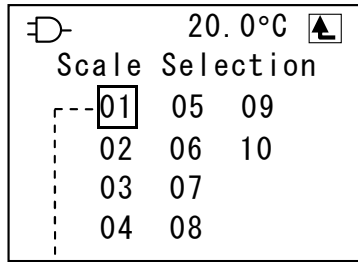

[Scale Setting (X) Screen]

Input the three measurement values from the VISCO.
Slide to select an item, then push to continue to the input screen.

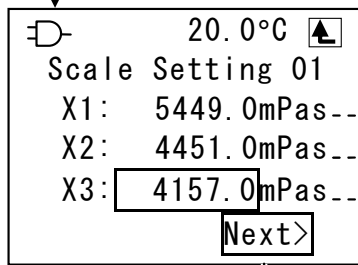

[Input Screen]

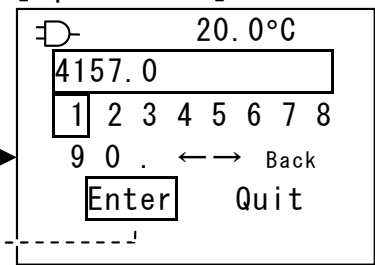

[Scale Setting (Y) Screen]

Input the three measurement values from the other viscometer.
Slide to select an item, then push to continue to the input screen.

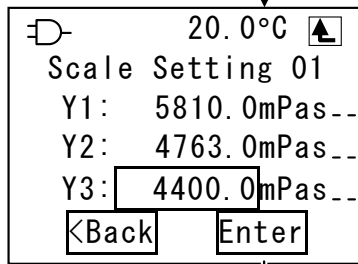

[Input Screen]

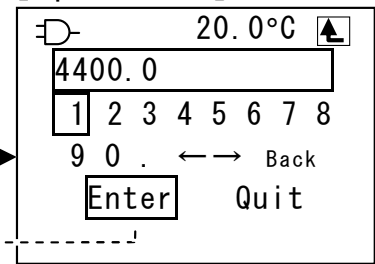

[Scale Setting (X) Screen]

Save

[Main Menu Screen]

Note Turning the user scale function ON/OFF and selecting a scale number is done from the measurement screen (p.30).

Note If attempting to input the same viscosity for X1, X2, X3, a beeping sound will indicate that this setting is invalid.
If attempting to input the same viscosity for Y1, Y2, Y3, a beeping sound will indicate that this setting is invalid.

About the input screen

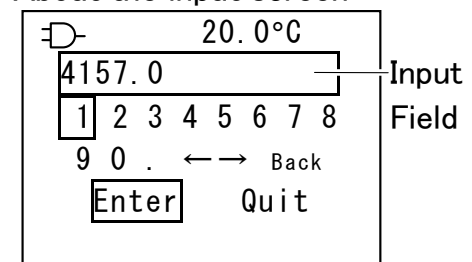

Slide to select a number value, then push to input it.

← →: use the arrows to move the cursor.



Back: select "Back" to delete the value to the left of the cursor.

memo Select "Quit" to cancel settings and return to the Scale Setting screen.

memo Values up to 1 decimal place can be input.

7-2-3 User Scale ON/OFF and Scale Number Settings

[Main Menu Screen]

Slide  to select an item, then push  to confirm the selection.

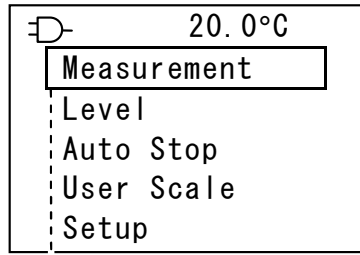

[Measurement Screen]

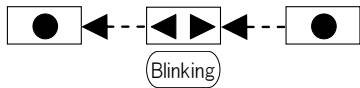

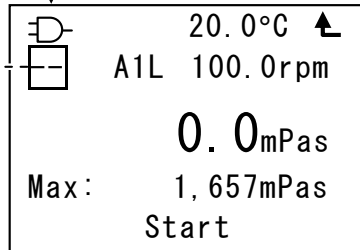

ON :01 to 10
 (Scale Number)
 OFF:--



8 Basic Settings (setup)

This section explains how to configure language, unit display, date/time and brightness settings.

8-1 Setup Screen

Slide  to select an item, then push  to confirm.

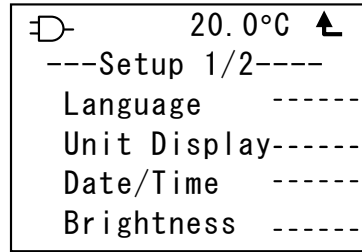

-  → Language ( p.31) [Japanese, English]
-  → Unit Display ( p.31) [Viscosity, Temperature]
-  → Date/Time ( p.32)
-  → Brightness ( p.32)

8-1-1 Language

Japanese
English

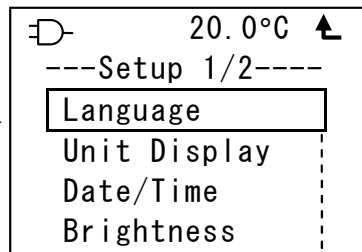

Confirm 

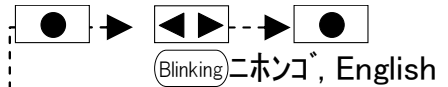
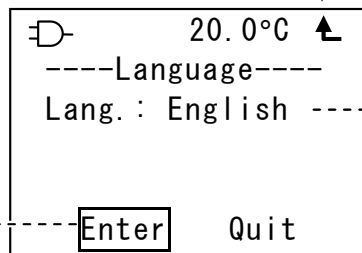

memo Select "Quit" to cancel settings and return to the setup screen.

8-1-2 Unit Display

Viscosity
[mPa·s, cP]
Temperature
[°C, °F]

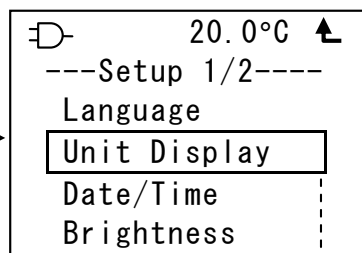

Confirm 

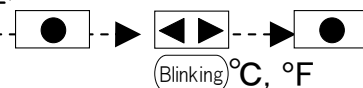
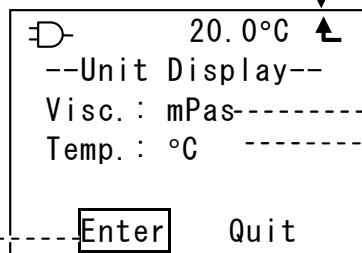

memo Select "Quit" to cancel settings and return to the setup screen.

8-1-3 Date/Time

MM/DD/YY
HH:MM:SS

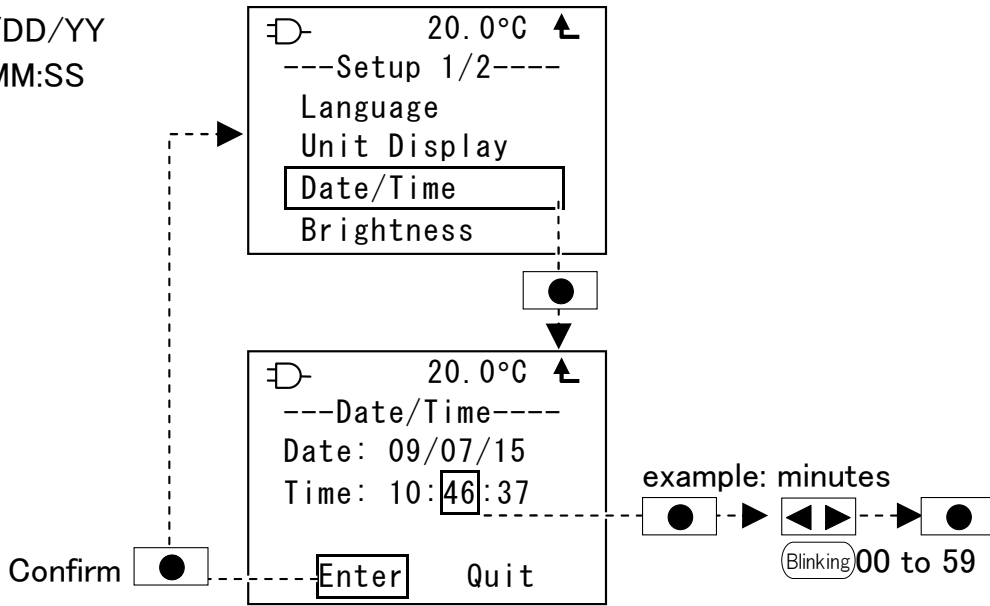

memo Select "Quit" to cancel settings and return to the setup screen.

memo "Beeping" tones will be emitted when an error occurs. Content containing errors will be indicated by flashing.

8-1-4 Brightness

5 levels

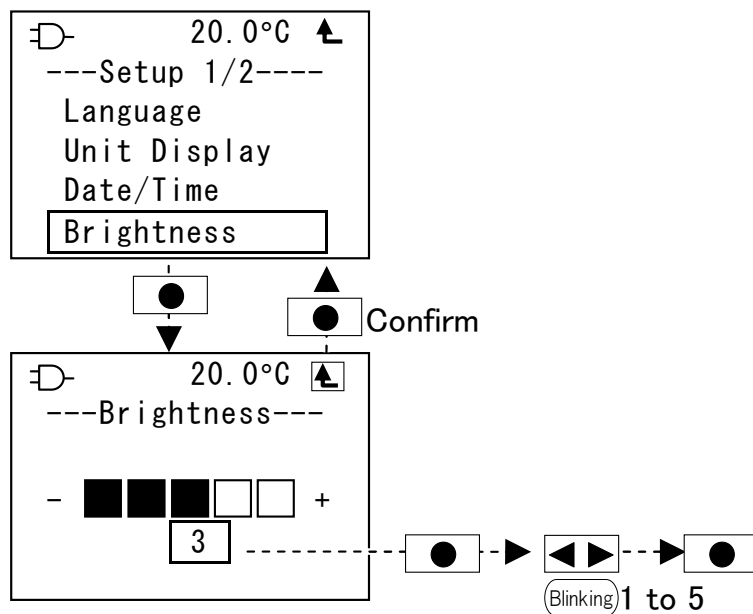

memo Level 1 is the dimmest setting, level 5 is the brightest.

9 Moving Average



Effective for reducing inconsistent display values when measuring samples that do not show a stable measurement value.

Displays the average (viscosity and torque %) of the 5 most recent readings.

For the first 4 readings, displays the average of the measurement values taken so far.

9-1 Moving Average ON/OFF

[Setup Screen (Setup 2/2)]

Slide  to select an item, then push  to confirm the selection.

Push  to check the box.

Confirm 

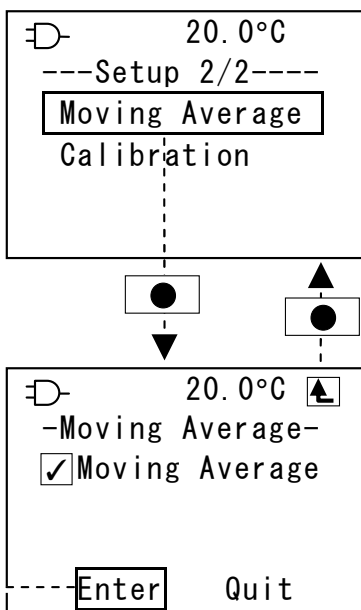

memo To turn off the moving average function, uncheck the selection item box.

memo Select "Quit" to discard settings and return to the setup 2/2 screen.

10 User Calibration

The instrument can be calibrated with standard liquid (1 point calibration). Select one standard liquid from among the following: JS200, JS500, JS1000, or JS2000 (refer to "Optional Accessories and Replacement Parts,"  p.41).

If abnormal measurement values occur, perform the following checks as illustrated below.

10-1 Troubleshooting Tips

See "Abnormal Measurement Values" on p.39.

Measure standard liquid (p.13)

 Check the viscosity of the standard liquid by using the temperature conversion chart included with the standard liquid as reference.

Viscosity will differ, depending on the temperature.

Within accuracy range → Normal

Outside accuracy range



Perform user calibration (p.35)



Measure standard liquid (p.13)

Within accuracy range → Normal

Outside accuracy range



Restore default calibration settings (p.38)



Measure standard liquid (p.13)

Within accuracy range → Normal

Outside accuracy range



Contact ATAGO for service and repair (p.44)



10-2 User Calibration

Note

- Ensure that the main unit, spindle, temperature sensor, beaker and standard liquid are fully acclimated to the ambient temperature before performing calibration.

10-2-1 Display

[Setup Screen (setup 2/2)]

Slide  to select an item, then push  to confirm the selection.

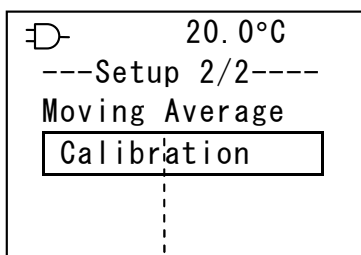

[Calibration Menu Screen]

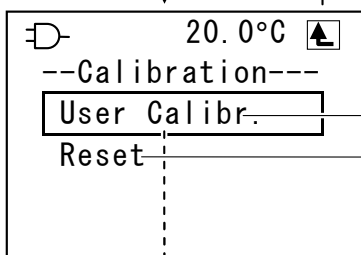

User calibration
Restore Default Calibration Settings ( p.38)

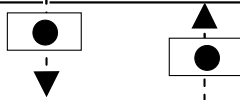

[Calibration Screen]

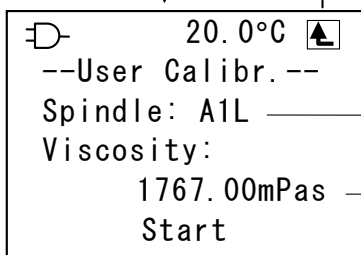

Spindle/beaker setting
Standard liquid viscosity setting

(example display)

10-2-2 Spindle/Beaker Settings

Refer to the "Maximum Measurement Values Guideline Chart" and select the most suitable spindle and beaker for your application (☞ from p.42).

[Calibration Screen]

☞ 20.0°C ▲
 --User Calibr.--
 Spindle: A1L
 Viscosity:
 1767.00mPas
 Start

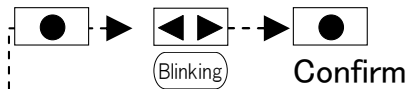

Select one of the items listed below:

Item	Spindle	Beaker
A1S	A1	S:15mL
A1L	A1	L:100mL
A2S	A2	S:15mL
A2L	A2	L:100mL
A3S	A3	S:15mL
A3L	A3	L:100mL

10-2-3 Standard Liquid Viscosity Settings

Check the viscosity of the standard liquid by using the temperature conversion chart included with the standard liquid as reference.

Viscosity will differ, depending on the temperature.

[Calibration Screen]

☞ 20.0°C ▲
 --User Calibr.--
 Spindle: A1L
 Viscosity:
 1767.00mPas
 Start



Slide ◀▶ to select a value, then push ● to input the value.

☞ 20.0°C
 1767.0
 1 2 3 4 5 6 7 8
 9 0 . ←→ Back
 Enter Quit

Input field

←→: use the arrows to move the cursor.

Back: select "Back" to delete the value to the left of the cursor.

memo Select "Quit" to cancel settings and return to the calibration screen.

memo Values up to 2 decimal places can be input.

10-2-4 Performing User Calibration

[Calibration Screen]

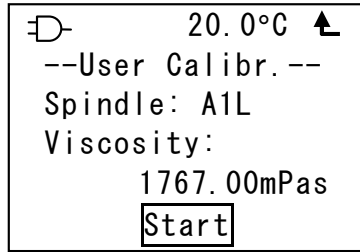

Prepare the spindle, temperature sensor (only when using the L Beaker) and standard liquid.

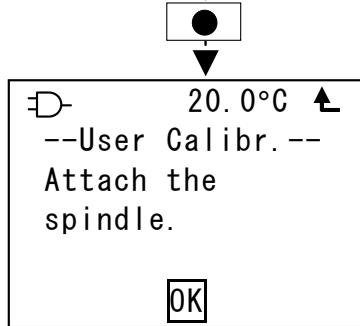

Spindle Preparation (👉 p.14)
 Temperature Sensor Preparation (👉 p.15)
 Sample Preparation (👉 p.15)
 Beaker Setup (👉 p.16)

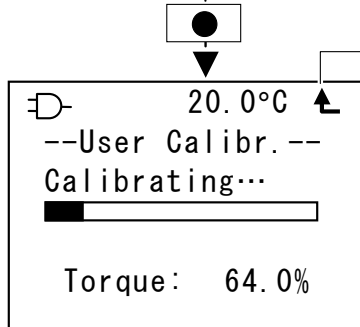

The variation (deviation) will be displayed and a "beep" will be emitted. Check the value. Recommended variation: within 10.0. If the variation exceeds 10.0, refer to p.39.

memo When an error occurs, "Calibration error." will be displayed and "beeping" tones will be emitted.

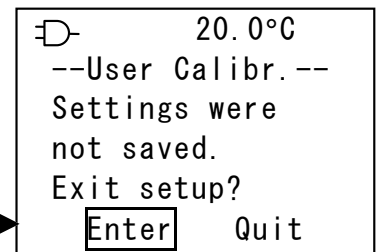
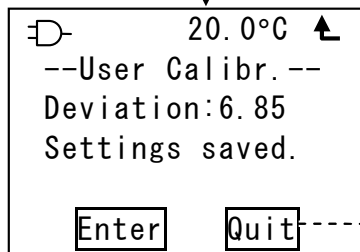

Beep

Save

Exit without saving

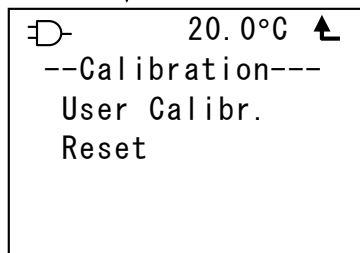

[Calibration Menu Screen]

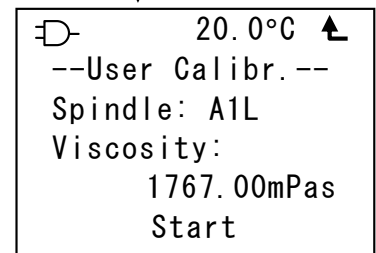

[Calibration Screen]

10-3 Restore Default Calibration Settings

Calibration settings can be restored to factory default values as described below.

[Calibration Menu Screen]

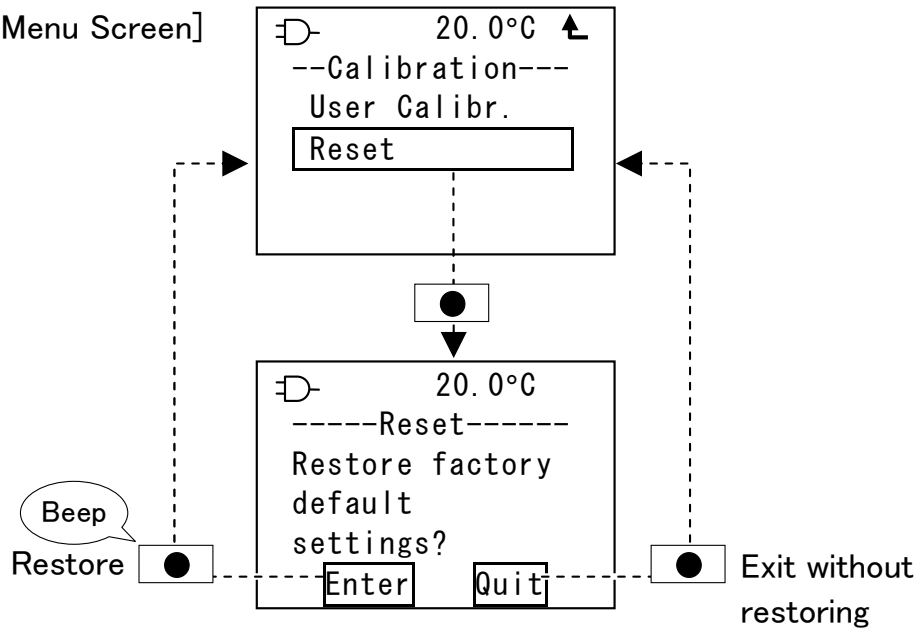

11 Abnormal Measurement Values

If abnormal measurement values occur, perform the following checks as illustrated below.

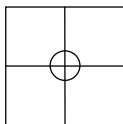
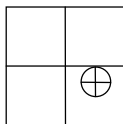
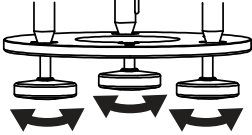
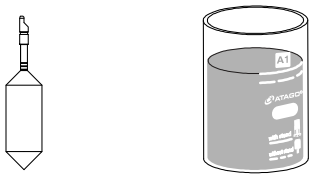
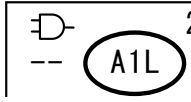
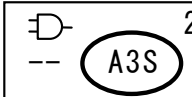
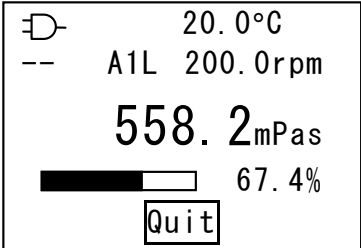
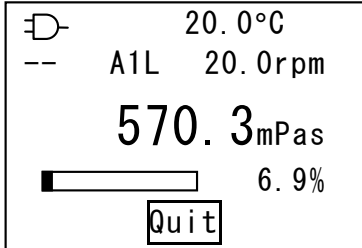
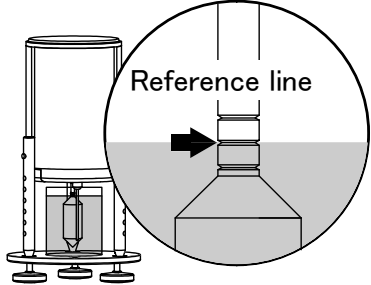
Checklist	Reference Pages and Solutions
<p>Main unit level check</p>	<p>☞ p.12</p> <div style="display: flex; justify-content: space-around; align-items: center;"> <div style="text-align: center;"> <p>○</p>  </div> <div style="text-align: center;"> <p>×</p>  </div> <div style="text-align: center;">  </div> <div style="text-align: left;"> <p>Use the stand screws to adjust the level.</p> </div> </div>
<p>Spindle and beaker combination setting check</p>	<p>☞ p.17</p> <div style="display: flex; justify-content: space-between;"> <div style="width: 45%;"> <p>example: A1L</p> <p>Spindle A1 L Beaker</p>  </div> <div style="width: 45%;"> <p>[Measurement Screen]</p> <div style="display: flex; justify-content: space-around; align-items: center;"> <div style="text-align: center;"> <p>○</p>  </div> <div style="text-align: center;"> <p>×</p>  </div> </div> </div> </div>
<p>Check that the torque is within the recommended range of 10 to 100% (and 5.0 to 100.0% when using Ultra Low Adapter (ULA)-Sample Adapter for Low Viscosity Sample (sold separately)).</p>	<p>If the value falls outside of the recommended range, change the speed, spindle and beaker accordingly to ensure the torque% falls within the recommended range.</p> <div style="display: flex; justify-content: space-around; align-items: center;"> <div style="text-align: center;"> <p>○</p>  </div> <div style="text-align: center;"> <p>×</p>  </div> </div> <p>[memo] Speed increase → Torque% increase Wider spindle → Torque% increase Smaller beaker → Torque% increase</p>
<p>Sample surface and spindle reference line alignment check</p>	<p>☞ p.16</p> 

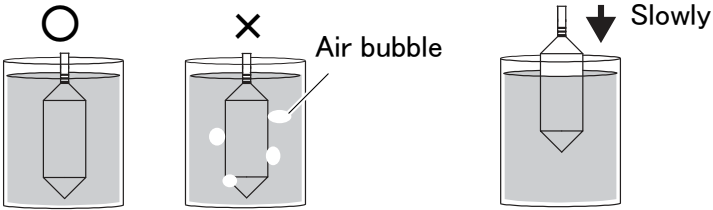
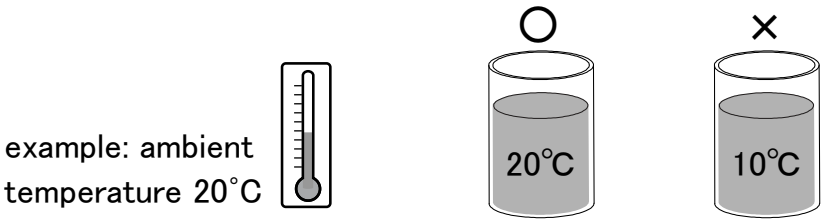
Checklist	Reference Pages and Solutions
Air bubble check	<p>If air bubbles are present, let the sample sit and settle in order to remove the air bubbles. When the main unit is set up, you can avoid air bubbles by slowly inserting the spindle in the sample.</p> 
Sample temperature check	<p>Ensure that the sample temperature is fully acclimated to the ambient conditions (example: Adjust the ambient temperature until it is stable, then let the sample sit for a while until it has acclimated to the temperature).</p>  <p>memo Viscosity will change depending on the temperature.</p>

12 Optional Accessories and Replacement Parts

Contact ATAGO or your ATAGO distributor to place an order or for any inquiries.

Name	Part No.	Notes
Standard liquid JS10	RE-	Manufactured by Nippon Grease Co., Ltd (500mL) For Ultra Low Adapter (ULA)-Sample Adapter for Low Viscosity Sample.
Standard liquid JS20	RE-	Manufactured by Nippon Grease Co., Ltd (500mL) For Ultra Low Adapter (ULA)-Sample Adapter for Low Viscosity Sample
Standard liquid JS50	RE-	Manufactured by Nippon Grease Co., Ltd (500mL) For Ultra Low Adapter (ULA)-Sample Adapter for Low Viscosity Sample
Standard liquid JS200	RE-89016	Manufactured by Nippon Grease Co., Ltd (500mL)
Standard liquid JS500	RE-89017	Manufactured by Nippon Grease Co., Ltd (500mL)
Standard liquid JS1000	RE-89018	Manufactured by Nippon Grease Co., Ltd (500mL)
Standard liquid JS2000	RE-89019	Manufactured by Nippon Grease Co., Ltd (500mL)
Spindle A1	RE-77104	
Spindle A2	RE-77105	
Spindle A3	RE-77106	
Ultra Low Adapter(ULA)-Sample Adapter for Low Viscosity Sample	RE-	For measuring low viscosity samples (1~2,000mPa·s)
S Beaker (15mL)	RE-79100	
L Beaker (100mL)	RE-79101	
Cup adapter (with 100pcs cups)	RE-78141	with 50 paper cups and 50 plastic cups
Paper cups (90mL 100pcs)	RE-79102	for Cup adapter
Plastic cups (90mL 100pcs)	RE-79103	for Cup adapter

memo Ultra Low Adapter will allow to measure low viscosity samples (1~2,000mPa·s). It only requires small amount of sample volume (16mL) to measure. (Only applicable for samples with aforementioned viscosity measurement range.)

memo By using the cup adapter, measurements can be taken in a disposable container in place of a glass beaker.
The cup adapter eliminates the hassle of cleaning glass beakers after measurement.

13 Supplementary Material

13-1 Maximum Measurement Values Guideline Chart



S Beaker (15mL)

Unit: mPa·s (cP)

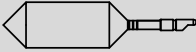
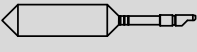
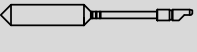
rpm	Spindle		
	A1 	A2 	A3 
0.5	180k	600k	2.1M
0.6	150k	500k	1.7M
1	91k	300k	1M
1.5	60k	200k	700k
2	45k	150k	520k
2.5	36k	120k	420k
3	30k	100k	350k
4	22k	75k	260k
5	18k	60k	210k
6	15k	50k	170k
10	9.1k	30k	100k
12	7.5k	25k	87k
20	4.5k	15k	52k
30	3k	10k	35k
50	1.8k	6k	21k
60	1.5k	5k	17k
100	910	3k	10k
150	600	2k	7k
200	450	1.5k	5.2k
250	360	1.2k	4.2k

Note

example: 4.5k = 4,500

example: 1.7M = 1,700,000

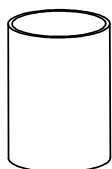

L Beaker (100mL)

Unit: mPa·s (cP)

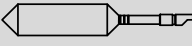
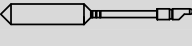
rpm	Spindle		
	A1 	A2 	A3 
0.5	320k	740k	2.3M
0.6	260k	610k	1.9M
1	160k	370k	1.1M
1.5	100k	240k	770k
2	80k	180k	570k
2.5	64k	140k	460k
3	53k	120k	380k
4	40k	92k	280k
5	32k	74k	230k
6	26k	61k	190k
10	16k	37k	110k
12	13k	30k	96k
20	8k	18k	57k
30	5.3k	12k	38k
50	3.2k	7.4k	23k
60	2.6k	6.1k	19k
100	1.6k	3.7k	11k
150	1k	2.4k	7.7k
200	810	1.8k	5.7k
250	640	1.4k	4.6k

Note

example: 4.5k = 4,500

example: 1.7M = 1,700,000

14 Warranty, Repair and Calibration

The instrument is warranted for one year from the date of purchase. Repair services will be performed free of charge while the instrument is under warranty. However, this warranty is void if the instrument shows evidence of the following:

- Having been disassembled by unauthorized personnel.
- Having been misused and/or operated outside the environmental specifications.

Repair services are available for a fee after the warranty expires.

Replacement Parts

Replacement parts are necessary to maintain performance of the instrument.

Replacement parts are generally available for 7 years after a model is discontinued.

However, please be aware that replacement parts may become unavailable from the suppliers within the 7-year period. Contact ATAGO, an authorized ATAGO distributor, or the original seller.

*Any repair services that require disassembly must be performed at an authorized ATAGO service center.

Calibration Recommendation

In accordance with the ISO quality management systems, ATAGO provides calibration services that comply with HACCP and GMP standards (only available for ATAGO products; a fee will be charged for this service).

The following documents will accompany an instrument after calibration:

Calibration certificate, traceability certificate, and traceability diagram.

Please have the serial number information ready when contacting us.

15 Specifications

Product name	VISCO	VISCO-895
Cat. No.	6800	6820
Measurement Scales	Viscosity • Temperature • Torque%	
Display Items	Viscosity • Temperature • Torque% • Speed • Spindle and beaker combination	
Measurement Range	Viscosity: A1 50 to 200,000mPa•s / 50 to 200,000cP A2 100 to 600,000mPa•s / 100 to 600,000cP A3 500 to 2,000,000mPa•s / 500 to 2,000,000cP Torque: 0.0 to 100.0% (recommended torque: 10.0 to 100.0%) Temperature: 0.0 to 100.0°C/32.0 to 212.0°F	
Resolution	Viscosity: lower than 100mPa•s 0.01mPa•s 100mPa•s or higher lower than 10,000mPa•s 0.1mPa•s 10,000mPa•s or higher 1mPa•s Torque: Lower than 10% 0.01% 10% or higher 0.1% Temperature: 0.1°C/0.1°F	
Measurement Accuracy	Viscosity: ±1% of Maximum Viscosity (Refer to the "Maximum Measurement Values Guideline Chart," from p.42) Temperature: ±0.2°C/±0.4°F	
Speed	0.5 to 250rpm Number of Speeds: 20	
Language	Japanese / English	
Sample Temperature Range	10.0 to 40.0°C / 50.0 to 104.0°F	
Environmental Conditions	<ul style="list-style-type: none"> • Use the instrument where the temperature is between 10 to 40°C • Use the instrument at an altitude below 2,000m (above sea level). • Use the instrument under the condition where humidity is 80% at 31°C or lower, falling linearly to 50% at 40°C. 	
Computer Output	Output: USB Mini-B – PC	
Power Supply	LR6 / AA alkaline batteries (x4) AC adapter input: AC100 to 240V. 50/60Hz, 0.3A output: 9V, 0.5A.	
Battery Life (Approx.)	Approx. 7 hours (continuous operation at 60rpm)	
Material	Main unit: SUS316L, aluminium Legs: SUS304 Stand: SUS304 Stand screw: SUS303	Main unit: aluminium Legs: aluminium Stand: aluminium Stand screw: aluminium
Dimensions and Weight	Main unit: 120(W)x120(D)x 200.6(H)mm 1.2kg (excluding batteries, spindles and temperature sensor) Stand+screw: 0.5kg Small volume beaker attachment:0.1kg	Main unit: 120(W)x120(D)x 200.6(H)mm 0.895kg (excluding batteries, spindles and temperature sensor) Stand+screw: 0.27kg Small volume beaker attachment: 0.1kg

ATAGO CO., LTD.

Headquarters: The Front Tower Shiba Koen, 23rd Floor
2-6-3 Shiba-koen, Minato-ku, Tokyo 105-0011, Japan
TEL: 81-3-3431-1943 FAX: 81-3-3431-1945
overseas@atago.net <http://www.atago.net/>

ATAGO U.S.A., Inc.

11811 NE First Street, Suite 101, Bellevue, WA 98005 U.S.A.
TEL: 1-425-637-2107 FAX: 1-425-637-2110
customerservice@atago-usa.com

ATAGO INDIA Instruments Pvt. Ltd.

TEL: 91-22-28544915 / 40713232
customerservice@atago-india.com

ATAGO THAILAND Co., Ltd.

TEL: 66-21948727-9 ,66-21171549
customerservice@atago-thailand.com

ATAGO BRASIL Ltda.

TEL: 55 16 3913-8400 customerservice@atago-brasil.com

ATAGO ITALIA s.r.l.

TEL: 39 02 36557267 customerservice@atago-italia.com

ATAGO CHINA Guangzhou Co., Ltd.

TEL: 86-20-38108256 info@atago-china.com

ATAGO RUSSIA Ltd.

TEL: 7-812-777-96-96 info@atago-russia.com

ATAGO NIGERIA Scientific Co., Ltd.

TEL: 234-707-558-1552 atagonigeria@atago.net